



u-blox GNSS product overview

Optimized cost and performance combined with easy integration

Product diversity for all kinds of applications

u-blox is a leading provider in GNSS solutions that are tailored for a wide variety of applications. Because we design our own GNSS chips, we can offer controlled quality, high performance, quick support, and long product life cycles.

Our positioning modules, SIPs (System-in-Package), chips, and smart antenna modules set the benchmark in performance and cost effectiveness, with quick delivery of accurate position data. Our wide portfolio includes standard precision, high precision, dead reckoning, functional safe GNSS, and precise timing solutions.

Technologies

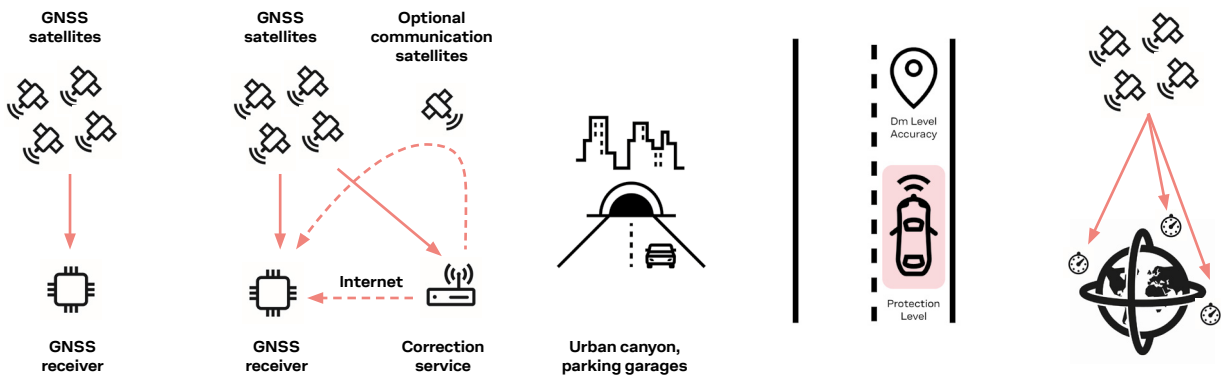

Standard precision (SPG)

Meter-level accuracy and low power consumption in cost-efficient products that are suitable for most needs

Application areas:

- Asset tracking
- Telematics
- Navigation
- Wearables and camera

u-blox services:

- AssistNow
- CloudLocate

High precision (HPG)

Sub-meter to centimeter-level accuracy using u-blox PointPerfect and third party correction services

Application areas:

- Automotive
- Unmanned vehicles
- High accuracy navigation

u-blox services:

- AssitNow
- PointPerfect

Dead Reckoning (DR)

100% positioning coverage even in parking garages, tunnels, and urban canyons

Application areas:

- Road-vehicle navigation
- Autonomous driving

Functional safe GNSS

Lane level accuracy (dm-level accuracy) plus high integrity via protection level computation

Application areas:

- Safety critical applications
- Autonomous driving
- ADAS L3and L4

u-blox services:

- PointSafe

Precise timing

Accurate clock and frequency generation based on satellite positioning technology

Application areas:

- Wireless comms
- Industrial
- Power distribution
- Finance applications

Accompanying u-blox services



AssistNow™ provides real-time online Assisted-GNSS with assured global availability. It accelerates GNSS performance and lowers power consumption. Integration is easy.



PointPerfect™ brings high-precision GNSS to mass market by delivering 3-6 cm accuracy and convergence within seconds.



CloudLocate™ delivers cloud-based positioning to extend the life of energy-constrained IoT applications up to 10x compared to standard GNSS power-saving approaches.



PointSafe™ is composed of an ISO 26262-certified safe correction service and safe on-board position engine software to deliver trusted positioning for next-generation autonomous driving vehicles.





Product selection guide



u-blox products come in various integration levels catering to needs, from low volume, ease of use scenarios to scalable solutions for customized applications. The product offering includes modules, SiPs, smart antenna modules, and chips.

	Chips	SiP modules	Modules	Smart antenna modules
Highlights	<ul style="list-style-type: none"> Full flexibility and small PCB footprint with minimized bill of materials for high volumes 	<ul style="list-style-type: none"> Highly integrated modules in the size of a chip Low design efforts 	<ul style="list-style-type: none"> Long form factor lifecycle (investment protection) Low design efforts Easy migration between SPG, HPG, and DR products 	<ul style="list-style-type: none"> Minimized design efforts Integrated antenna: no radio frequency expertise needed
Product grade	<ul style="list-style-type: none"> Automotive Professional Standard 	<ul style="list-style-type: none"> Professional Standard 	<ul style="list-style-type: none"> Automotive Professional Standard 	<ul style="list-style-type: none"> Professional
Package size (pieces/reel)	<ul style="list-style-type: none"> 4000 pieces 	<ul style="list-style-type: none"> 500 to 1000 pieces 	<ul style="list-style-type: none"> 250 to 500 pieces 	<ul style="list-style-type: none"> 250 to 500 pieces
Dominant market	<ul style="list-style-type: none"> Automotive Industrial Consumer 	<ul style="list-style-type: none"> Industrial Consumer 	<ul style="list-style-type: none"> Automotive Industrial 	<ul style="list-style-type: none"> Industrial

Advantages to using modules

	Quick to market and minimal design risk	<ul style="list-style-type: none"> Plug and play – just connect an antenna and power No radio frequency or hardware qualification needed Fully qualified, tested, and certified
	Future proof and reduced supplier base	<ul style="list-style-type: none"> Pin-to-pin and software compatibility across generations Only one supplier for functional block, thus reducing sourcing complexity High quality components for consistent performance and lowest ppm
	Lower engineering cost and investment for testing	<ul style="list-style-type: none"> One standard SMD component for simple assembly and production testing No test infrastructure investment One-stop technical support (field support and returns)















Product grades

	 Standard grade	 Professional grade	 Automotive grade	
Environmental conditions	Consumer environment	Industrial environment	Automotive environment	Safety critical environment
Temperature	-20 °C to +65 °C	-40 °C to +85 °C	-40 °C to +85 °C or extended (up to +105 °C on some products)	-40 °C to +105 °C
Product qualification	JESD47 (ICs) Subset of AEC-Q104, non-biased (modules)	AEC-Q100 (ICs) u-blox policy / sub-set of AEC-Q104 (modules)	AEC-Q100 (ICs) AEC-Q104 (modules)	AEC-Q100 (ICs) ASIL-B (ISO 26262)
Process levels for design, manufacturing, and testing	<ul style="list-style-type: none"> 100% outgoing test Product traceability PCN process Failure analysis 	Standard grade, plus: 100% automatic X-ray and optical inspection of modules	Professional grade, plus: PPAP, automotive test flow, ISO/TS 16949 manufacturing, component traceability, 8D failure reporting, automotive PCN process, long product life cycles, 0-ppm program	Automotive grade, plus: ISO 26262 certified component, Safety Element Out of Context (SEooC), ISO 21434, SOTIF



Product selector table

Our form factor roadmap allows for easy migration from older to newer generations and for similar designs with different technologies or levels of precision. For a detailed view of our product offering, see: www.u-blox.com/product-selector.

Sizes	Platform or form factor	L1 band	L2 band	L5 band	Standard precision	High precision	Dead reckoning	Functional safe	Precise timing
 4.0 x 4.0 mm 5.0 x 5.0 mm	u-blox F10 Chip	•		•	•				
 4.0 x 4.0 mm	u-blox M10 Chip	•			•				
 5.0 x 5.0 mm	u-blox A9 Chip	•	•	•		•		•	
 5.0 x 5.0 mm	u-blox F9 Chip	•	•	•		•	•		
 5.0 x 5.0 mm	u-blox M9 Chip	•			•		•		
 5.0 x 5.0 mm	u-blox M8 Chip	•			•		•		
 4.5 x 4.5 mm	MIA SiP module	•		•	•				
 4.5 x 4.5 mm	ZOE SiP module	•			•				
 7.0 x 7.0 mm	EVA SiP module	•			•				
 9.7 x 10.1 mm	MAX Module	•		•	•				
 12.2 x 16.0 mm	NEO Module	•		•	•	•	•		•
 17.0 x 22.0 mm	ZED Module	•	•	•		•	•		•
 17.0 x 22.0 mm	LEA Module	•	•	•	•				•
 9.6 x 14.0 mm	CAM Smart antenna module	•			•				
 15.5 x 15.5 mm	SAM Smart antenna module	•			•				



u-blox GNSS product naming

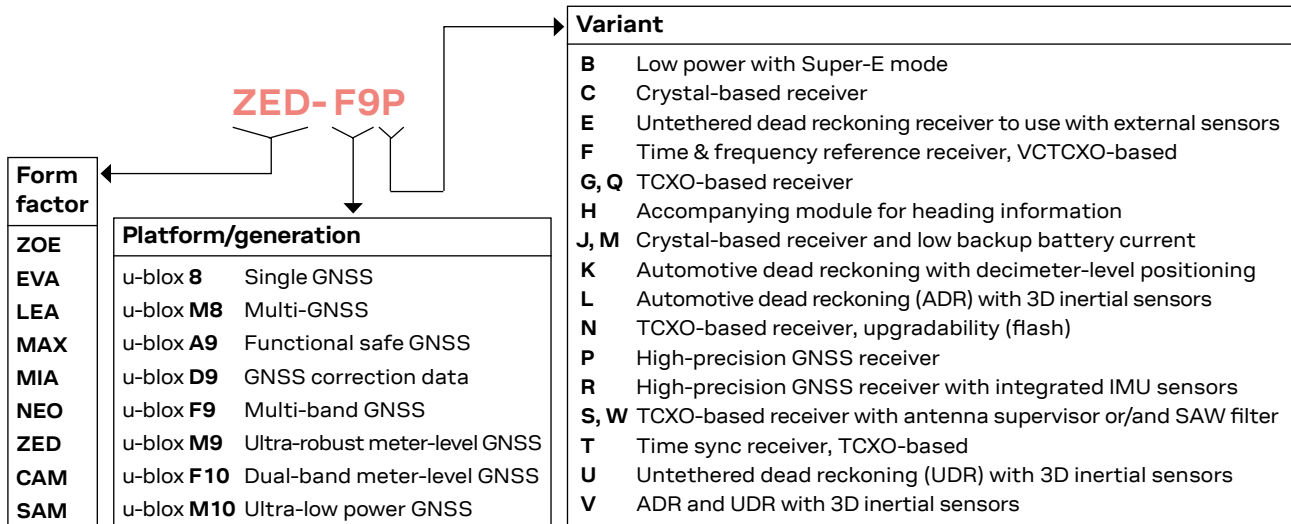

Your benefits working with u-blox GNSS products



Competent technical support worldwide

- GNSS experts for more than 25 years
- World-wide technical support



Quick time to market

- Short and reliable delivery times
- Module form factor consistency



High quality

- Global leader in positioning and wireless communication
- In-house chip technology



Broad spectrum of solutions

- Broad portfolio for different technologies - Wi-Fi, Bluetooth, cellular, and GNSS
- Full hardware, support tool, and services offering for a wide range of applications



Security

- Spoofing and jamming detection

Further information

For contact information, see www.u-blox.com/contact-u-blox.

For more product details and ordering information, see the individual product data sheets.

Legal Notice:

u-blox or third parties may hold intellectual property rights in the products, names, logos and designs included in this document. Copying, reproduction, or modification of this document or any part thereof is only permitted with the express written permission of u-blox. Disclosure to third parties is permitted for clearly public documents only.

The information contained herein is provided "as is". No warranty of any kind, either express or implied, is made in relation to the accuracy, reliability, fitness for a particular purpose, or content of this document. This document may be revised by u-blox at any time. For most recent documents, please visit www.u-blox.com.