

NEO-M8L-05B

u-blox M8 automotive dead reckoning modules with 3D sensors

Data sheet



Abstract

The NEO-M8L-05B ADR module provides continuous accurate navigation under all signal conditions. The solution combines real-time positioning from GPS/QZSS, GLONASS, BeiDou, and Galileo satellite systems together with vehicle speed information and integrated 3D sensors.

Document information

Title	NEO-M8L-05B	
Subtitle	u-blox M8 automotive dead reckoning modules with 3D sensors	
Document type	Data sheet	
Document number	UBX-20004500	
Revision and date	R05	16-Dec-2022
Document status	Early Production Information	
Disclosure restriction	C1-Public	

Product status	Corresponding content status	
In Development / Prototype	Objective Specification	Target values. Revised and supplementary data will be published later.
Engineering Sample	Advance Information	Data based on early testing. Revised and supplementary data will be published later.
Initial Production	Early Production Information	Data from product verification. Revised and supplementary data may be published later.
Mass Production / End of Life	Production Information	Document contains the final product specification.

This document applies to the following products:

Product name	Type number	ROM/FLASH version	PCN/IN reference
NEO-M8L-05B	NEO-M8L-05B-00	Flash FW3.01 ADR 4.31	UBX-20014805, UBX-22039049

u-blox or third parties may hold intellectual property rights in the products, names, logos, and designs included in this document. Copying, reproduction, or modification of this document or any part thereof is only permitted with the express written permission of u-blox. Disclosure to third parties is permitted for clearly public documents only.

The information contained herein is provided "as is" and u-blox assumes no liability for its use. No warranty, either express or implied, is given, including but not limited to, with respect to the accuracy, correctness, reliability, and fitness for a particular purpose of the information. This document may be revised by u-blox at any time without notice. For the most recent documents, visit www.u-blox.com.

Copyright © u-blox AG.

Contents

Document information	2
Contents	3
1 Functional description	5
1.1 Overview	5
1.2 Product features	5
1.3 Performance.....	6
1.4 Block diagram	7
1.5 Supported GNSS constellations	7
1.5.1 GPS	8
1.5.2 GLONASS	8
1.5.3 BeiDou	8
1.5.4 Galileo	8
1.6 Assisted GNSS (A-GNSS).....	8
1.6.1 AssistNow™ Online.....	8
1.6.2 AssistNow™ Offline.....	9
1.6.3 AssistNow™ Autonomous	9
1.7 Augmentation systems	9
1.7.1 Satellite-based augmentation system (SBAS)	9
1.7.2 QZSS	9
1.7.3 QZSS L1S SLAS.....	9
1.7.4 IMES	10
1.7.5 Differential GPS (D-GPS).....	10
1.8 Broadcast navigation data and satellite signal measurements	10
1.9 Automotive dead reckoning (ADR)	10
1.10 Odometer	11
1.11 Data logging	11
1.12 Geofencing.....	11
1.13 Message integrity protection	11
1.14 Spoofing detection	11
1.15 TIMEPULSE	12
1.16 Protocols and interfaces	12
1.17 Interfaces.....	12
1.17.1 UART	12
1.17.2 USB	12
1.17.3 SPI	12
1.17.4 Display Data Channel (DDC)	13
1.17.5 WHEELTICK (Speed-pulse) and FWD (Forward/reverse) indication.....	13
1.18 Clock generation.....	13
1.18.1 Oscillators	13
1.18.2 Real-time clock (RTC)	13

1.19 Power management	14
1.19.1 Power control.....	14
1.20 Antenna.....	14
2 Pin definition.....	15
2.1 Pin assignment.....	15
3 Configuration management.....	16
3.1 Interface selection (D_SEL)	16
4 Electrical specification.....	17
4.1 Absolute maximum rating.....	17
4.2 Operating conditions.....	18
4.3 Indicative current requirements	18
4.4 SPI timing diagrams	19
4.4.1 Timing recommendations.....	19
4.5 DDC timing	19
5 Mechanical specifications.....	20
6 Reliability tests and approvals.....	21
6.1 Reliability tests.....	21
6.2 Approvals.....	21
7 Product handling and soldering	22
7.1 Packaging	22
7.1.1 Reels.....	22
7.1.2 Tapes.....	22
7.2 Shipment, storage and handling	23
7.2.1 Moisture sensitivity levels	23
7.2.2 Reflow soldering.....	23
7.2.3 ESD handling precautions	23
8 Default messages	24
9 Labeling and ordering information	25
9.1 Product labeling.....	25
9.2 Explanation of codes	25
9.3 Ordering codes.....	25
Appendix.....	26
A Glossary	26
Related documents	27
Revision history	27
Contact.....	28

1 Functional description

1.1 Overview

The NEO-M8L-05B 3D automotive dead reckoning (ADR) module is designed for the latest interactive navigation, telematics and vehicle-to-everything (V2X) applications. The module combines GNSS, on-board inertial sensing, and speed information from the vehicle to provide continuous and accurate 3D positioning. The performance of u-blox's ADR products benefit from experience in demanding, first-fit passenger-car applications, the latest multi-axis sensor technology and advancements in u-blox's GNSS and navigation technology, particularly in highly urban environments, and it is backed by u-blox's automotive grade manufacturing and support. The NEO-M8L-05B delivers the ideal solution where reliability and navigation performance are the priorities.

The NEO-M8L-05B may be fitted in any position and includes a number of additional features that help ensure error-free and flexible installation. These include automatic configuration of vehicle speed or wheel tick inputs, which can be delivered as hardware signals or via messages derived from the vehicle CAN bus.

The intelligent combination of GNSS and sensor measurements enables accurate, real-time positioning, speed and heading information at rates up to 30 Hz. Access to native, high-rate sensor data also enables host applications to make full use of the receiver's assets.

The NEO-M8L-05B supports reception of Galileo, GPS, GLONASS, BeiDou and QZSS. The module provides high sensitivity and fast GNSS signal acquisition and tracking.

The standard u-blox NEO form-factor enables flexibility in design and easy substitution with other NEO modules, including the u-blox NEO-M8U untethered dead reckoning (UDR) product. UART, USB, DDC (I2C-compliant) and SPI interface options provide flexible connectivity and enable simple integration with most u-blox cellular modules.

NEO-M8L-05B modules use GNSS chips qualified according to AEC-Q100. Modules are manufactured in ISO/TS 16949 certified sites and fully tested on a system level. Qualification tests are performed as stipulated in the ISO 16750 standard "Road vehicles – Environmental conditions and testing for electrical and electronic equipment". This automotive grade product adheres to automotive industry standard quality specifications and production flow.

u-blox's AssistNow service supplies aiding information, such as ephemeris, almanac and time, reducing the time-to-first fix significantly and improving acquisition sensitivity. AssistNow data with u-blox M8 modules supports GPS, BeiDou and GLONASS constellations for faster acquisition than a GPS-only assistance. The extended validity of AssistNow Offline data (up to 35 days) and AssistNow Autonomous data (up to 6 days) provides the benefits of faster acquisition for longer durations since last use.

1.2 Product features

For an overview of the product features, see the NEO-M8L Product summary [7].

1.3 Performance

Parameter	Specification					
Receiver type	72-channel u-blox M8 engine GPS L1C/A, SBAS L1C/A, QZSS L1C/A, QZSS L1-SAIF, GLONASS L1OF, BeiDou B1I, Galileo E1B/C					
Accuracy of time pulse signal	RMS	30 ns				
	99%	60 ns				
Frequency of time pulse signal	0.25 Hz...10 MHz (configurable)					
Operational limits ¹	Dynamics	≤ 4 g				
	Altitude	50,000 m				
	Velocity	500 m/s				
Velocity accuracy ²	0.05 m/s					
Heading accuracy ²	0.3 degrees					
Position error during GNSS loss ³	Rear wheel ticks					12%
	Gyro + speed pulse					3%
	Gyro + speed pulse + accelerometer					2%
Max navigation update rate, High navigation rate output	30 Hz					
Max navigation update rate (PVT) ⁴	2 Hz					
Navigation latency High navigation rate output	<10 ms					
Max sensor measurement output rate	100 Hz					
GNSS		GPS & GLONASS	GPS	GLONASS	BeiDou	Galileo
Time-To-First-Fix ⁵	Cold start	26 s	30 s	31 s	39 s	57 s
	Hot start	1.5 s	1.5 s	1.5 s	1.5 s	1.5 s
	Aided starts ⁶	3 s	3 s	3 s	7 s	7 s
Sensitivity ^{7 8}	Tracking & Navigation	-160 dBm	-160 dBm	-157 dBm	-160 dBm	-154 dBm
	Reacquisition	-160 dBm	-159 dBm	-156 dBm	-155 dBm	-152 dBm
	Cold start	-148 dBm	-147 dBm	-145 dBm	-143 dBm	-133 dBm
	Hot start	-157 dBm	-156 dBm	-155 dBm	-155 dBm	-151 dBm
Horizontal position accuracy	Autonomous ⁹	2.5 m	2.5 m	4.0 m	3.0 m	TBC ¹⁰
	With SBAS ¹¹	1.5 m	1.5 m	-	-	-
Altitude accuracy	With SBAS ¹²	3.5 m	3.0 m	7.0 m	5.0 m	-

Figure 1: NEO-M8L-05B performance in different GNSS modes (default: concurrent reception of GPS and GLONASS)

¹ Configured for Airborne < 4 g platform

² 50% at 30 m/s

³ Typical error incurred without GNSS as a percentage of distance travelled, applicable to four-wheel road vehicle

⁴ Rates with SBAS and QZSS enabled for > 98% fix report rate under typical conditions

⁵ All satellites at -130 dBm, except Galileo at -127 dBm

⁶ Dependent on aiding data connection speed and latency

⁷ Demonstrated with a good external LNA

⁸ Configured min. CNO of 6 dB/Hz, limited by FW with min. CNO of 20 dB/Hz for best performance

⁹ CEP, 50%, 24 hours static, -130 dBm, > 6 SVs

¹⁰ To be confirmed when Galileo reaches full operational capability

¹¹ CEP, 68%, open sky, > 6 GPS SVs, HDOP ≤ 1.5

¹² CEP, 50%, 24 hours static, -130 dBm, > 6 SVs

1.4 Block diagram

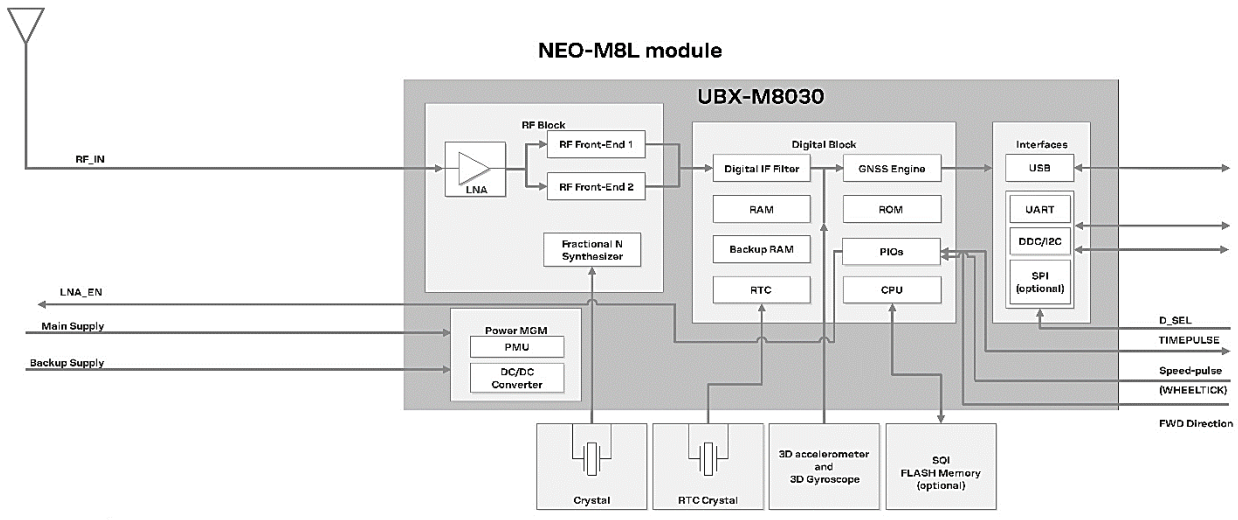

Figure 2: NEO-M8L-05B block diagram

1.5 Supported GNSS constellations

The NEO-M8L-05B GNSS module is a concurrent GNSS receiver that can receive and track multiple GNSS systems: GPS, Galileo, GLONASS and BeiDou. Owing to the dual-frequency RF front-end architecture, either GLONASS or BeiDou can be processed concurrently with GPS and Galileo signals, providing reception of three GNSS systems. By default, the M8 receivers are configured for concurrent GPS and GLONASS, including SBAS and QZSS reception. If power consumption is a key factor, the receiver should be configured for single GNSS operation using GPS, Galileo, GLONASS or BeiDou and disabling QZSS and SBAS.

QZSS, IMES and SBAS augmentation systems share the same frequency band as GPS and can always be processed in conjunction with GPS.

The modules can be configured to receive any single GNSS constellation or within the set of permissible combinations shown below.

GPS	Galileo	GLONASS	BeiDou
•	•	–	–
•	•	•	–
•	•	–	•
•	–	•	–
•	–	–	•
–	•	•	–
–	•	–	•
–	–	•	•

Figure 3: Permissible GNSS combinations (• = enabled)

- The augmentation systems SBAS and QZSS can be enabled only if GPS operation is configured.
- Galileo is not enabled as the default configuration.

1.5.1 GPS

The NEO-M8L-05B positioning module is designed to receive and track the L1C/A signals provided at 1575.42 MHz by the global positioning system (GPS). The NEO-M8L-05B can receive and process GPS concurrently with GLONASS or BeiDou.

1.5.2 GLONASS



The NEO-M8L-05B positioning module can receive and process GLONASS concurrently with GPS or BeiDou. The Russian GLONASS satellite system is an alternative system to the US-based global positioning system (GPS). The NEO-M8L-05B module is designed to receive and track the L1OF signals GLONASS provides at $1602 \text{ MHz} + k \cdot 562.5 \text{ kHz}$, where k is the satellite's frequency channel number ($k = -7, \dots, 5, 6$). The ability to receive and track GLONASS L1OF satellite signals enables the design of GLONASS receivers where required by regulations.

1.5.3 BeiDou

The NEO-M8L-05B positioning module can receive and process BeiDou concurrently with GPS or GLONASS. The NEO-M8L-05B module is designed to receive and track the B1 signals provided at 1561.098 MHz by the BeiDou Navigation Satellite System. The ability to receive and track BeiDou B1 satellite signals in conjunction with GPS results in higher coverage, improved reliability and better accuracy. Global coverage is scheduled for 2020.

1.5.4 Galileo

The NEO-M8L-05B positioning module can receive and track the E1-B/C signals centered on the GPS L1 frequency band. GPS and Galileo signals can be processed concurrently, together with either the BeiDou or GLONASS signals, enhancing coverage, reliability and accuracy. The SAR return link message (RLM) parameters for both short and long versions are decoded by the receiver and made available to users via UBX proprietary messages.

-  Galileo has been implemented according to ICD release 1.3 (December 2016). Since the Galileo satellite system has only recently reached Initial Services (IS) and not yet Full Operational Capability (FOC), changes to the Galileo signal specification (OS SIS ICD) remain theoretically possible. u-blox therefore recommends provision for flash firmware update in designs utilizing Galileo signals in the unlikely event of a change to the Galileo signal specification (OS SIS ICD).
-  Galileo reception is disabled by default, but can be enabled by sending a configuration message (UBX-CFG-GNSS) to the receiver. See the u-blox 8 / u-blox M8 Receiver Description / Protocol Specification [2] for more information.

1.6 Assisted GNSS (A-GNSS)

Supply of aiding information, such as ephemeris, almanac, or approximate position and time, will reduce the time-to-first-fix significantly and improve the acquisition sensitivity. The NEO-M8L-05B supports the u-blox AssistNow Online and AssistNow Offline A-GNSS services, supports AssistNow Autonomous, and is OMA SUPL compliant.

1.6.1 AssistNow™ Online

With AssistNow Online, an internet-connected GNSS device downloads assistance data from u-blox's AssistNow Online Service at system start-up. AssistNow Online is network-operator independent and globally available. Devices can be configured to request only ephemeris data for those satellites currently visible at their location, thus minimizing the amount of data transferred.

1.6.2 AssistNow™ Offline

With AssistNow Offline, users download u-blox's long-term orbit data from the internet at their convenience. The orbit data can be stored in the NEO-M8L-05B GNSS receiver's SQI flash memory. Thus the service requires no connectivity at system start-up, enabling a position fix within seconds, even when no network is available. AssistNow Offline offers augmentation for up to 35 days.

1.6.3 AssistNow™ Autonomous

AssistNow Autonomous provides aiding information without the need for a host or external network connection. Based on previous broadcast satellite ephemeris data which has been downloaded to and stored by the GNSS receiver, AssistNow Autonomous automatically generates accurate satellite orbital data ("AssistNow Autonomous data") that is usable for future GNSS position fixes. The concept capitalizes on the periodic nature of GNSS satellites: their position in the sky is basically repeated every 24 hours. By capturing strategic ephemeris data at specific times over several days, the receiver can predict accurate satellite ephemeris for up to six days after initial reception.

The AssistNow Autonomous benefits are:

- Faster fix in situations where GNSS satellite signals are weak.
- No connectivity required.
- Compatible with AssistNow Online and Offline (can work stand-alone, or in tandem with these services).
- No integration effort; calculations are done in the background, transparent to the user.

 For more details, see the u-blox 8 / u-blox M8 Receiver Description / Protocol Specification [2] and the MGA Services User Guide [5].

1.7 Augmentation systems

1.7.1 Satellite-based augmentation system (SBAS)

The NEO-M8L-05B positioning module supports SBAS. These systems supplement GPS data with additional GPS augmentation data within defined service areas. The systems broadcast augmentation data via satellite and this information can be used by GNSS receivers to improve the resulting precision. In some cases, SBAS satellites can be used as additional satellites for ranging (navigation), further enhancing precision and availability.

 For more details, see the u-blox 8 / u-blox M8 Receiver Description / Protocol Specification [2].

1.7.2 QZSS



The Quasi-Zenith Satellite System (QZSS) is a regional navigation satellite system that transmits additional GPS L1C/A signals for the Pacific region covering Japan and Australia. The NEO-M8L-05B positioning module is able to receive and track these signals concurrently with GPS signals, resulting in better availability especially under bad signal conditions, for example, in urban canyons.

1.7.3 QZSS L1S SLAS

QZSS SLAS (sub-meter level augmentation service) is an augmentation technology which provides correction data for pseudoranges of GPS and QZSS satellites. With the QZSS SLAS enabled, u-blox receivers autonomously select the most suitable ground monitoring stations (GMS) based on the user's location. The correction stream of this GMS will then be applied to the measurements in order to improve the position accuracy.

1.7.4 IMES

The Japanese Indoor Messaging System (IMES) system is used for indoor position reporting using low-power transmitters which broadcast a GPS-like signal. The NEO-M8L-05B module can be configured to receive and demodulate the signal to provide an in-door location estimate.

-  This service is authorized and available only in Japan.
-  IMES reception is disabled by default.

1.7.5 Differential GPS (D-GPS)

u-blox NEO-M8L-05B receiver supports Differential-GPS data according to RTCM 10402.3 “RECOMMENDED STANDARDS FOR DIFFERENTIAL GNSS”. The use of Differential-GPS data improves GPS position accuracy. RTCM cannot be used together with SBAS. The RTCM implementation supports the following RTCM 2.3 messages:

Message type	Description
1	Differential GPS corrections
2	Delta Differential GPS corrections
3	GPS reference station parameters
9	GPS partial correction set

Figure 4: Supported RTCM 2.3 messages

-  For more details, see the u-blox 8 / u-blox M8 Receiver Description / Protocol Specification [2].

1.8 Broadcast navigation data and satellite signal measurements

The NEO-M8L-05B can output all of the GNSS broadcast data upon reception from tracked satellites. This includes all of the supported GNSS signals plus the augmentation services SBAS, QZSS. The receiver also makes available the tracked satellite signal information, that is, raw code phase and Doppler measurements in a form aligned to the Radio Resource LCS Protocol (RRLP) [6].

The L1- SAIF signal provided by QZSS can be enabled for reception via a GNSS configuration message.

-  For more details, see the u-blox 8 / u-blox M8 Receiver Description / Protocol Specification [2].

1.9 Automotive dead reckoning (ADR)

u-blox’s proprietary automotive dead reckoning (ADR) solution uses a 3D inertial measurement unit (IMU) included within the module and speed pulses from the vehicle’s wheel tick sensor. Alternatively, the vehicle speed data can be provided in terms of messages via a serial interface. Sensor data and GNSS signals are processed together, achieving 100% coverage, with highly accurate and continuous positioning even in GNSS-hostile environments (for example, urban canyons) or in case of GNSS signal absence (for example, tunnels and parking garages).

Wheel tick or speed sensor rate variations are calibrated automatically and continuously by the module, accommodating, for example, vehicle tire wear automatically.

-  For more details, see the u-blox 8 / u-blox M8 Receiver Description / Protocol Specification [2].

The NEO-M8L-05B combines GNSS and dead reckoning measurements and computes a position solution at rates of up to 2 Hz. These solutions are reported in standard NMEA, UBX-NAV-PVT and similar messages. High navigation rate output message (UBX-HNR-PVT) extends these results with IMU-only data to deliver accurate, low-latency position measurements at rates of up to 30 Hz.

Dead reckoning allows navigation to commence as soon as power is applied to the module (that is, before a GNSS fix has been established) under the following conditions:

- The vehicle has not been moved without power applied to the module.
- At least a dead-reckoning fix was available when the vehicle was last used.
- A back-up supply has been available for the module since the vehicle was last used.

 The save-on-shutdown feature can be used in case no back-up supply is available. All information necessary will be saved to flash and read from the flash upon restart. For more details, see the u-blox 8 / u-blox M8 Receiver Description / Protocol Specification [2].

For post-processing applications, raw sensor data is available from message UBX-ESF-MEAS. Each message includes the time of measurement.

1.10 Odometer

The odometer provides information on travelled ground distance (in meters) using position and velocity measurements from the combined GNSS/DR navigation solution. For each computed traveled distance since the last odometer reset, the odometer estimates a 1-sigma accuracy value. The total cumulative ground distance is maintained and saved in the BBR memory.

The odometer feature is disabled by default. For more details, see the u-blox 8 / u-blox M8 Receiver Description / Protocol Specification [2].

1.11 Data logging

The u-blox NEO-M8L-05B receiver can be used in data logging applications. The data logging feature enables continuous storage of position, velocity and time information to an onboard SQL flash memory. It can also log the distance reported by the odometer. The information can be downloaded from the receiver later for further analysis or for conversion to a mapping tool. For more information, see the u-blox 8 / u-blox M8 Receiver Description / Protocol Specification [2].

1.12 Geofencing

The u-blox NEO-M8L-05B module supports up to four circular Geofencing areas defined on the Earth's surface using a 2D model. Geofencing is active when at least one Geofence is defined, the current status can be found by polling the receiver. A PIO pin can be nominated to indicate the status to, for example, wake up a host on activation.

1.13 Message integrity protection

The NEO-M8L-05B module provides a function to prevent a third party interfering with the UBX message stream sent from receiver to host. The security mechanism essentially 'signs' nominated messages with a following message containing an MD5-generated hash of the nominated message. This message signature is then compared with one generated by the host to determine if the message data has been altered.

1.14 Spoofing detection

Spoofing means that a malicious third party tries to control the reported position via a fake GNSS broadcast signal. This may result in reporting an incorrect position, velocity or time. To combat this, the module includes spoofing detection measures to alert the host when signals appear to be suspicious. The receiver combines a number of checks on the received signals looking for inconsistencies across several parameters.

 Note that this feature does not guarantee detection of all spoofing attacks.

1.15 TIMEPULSE

A configurable time pulse signal is available with the NEO-M8L-05B module.

The TIMEPULSE output generates pulse trains that are synchronized with the GPS or UTC time grid with intervals configurable over a wide frequency range. Thus it may be used as a low-frequency time synchronization pulse or as a high-frequency reference signal.

 The NEO-M8L-05B time-pulse output is configured using messages for “TIMEPULSE2.” This pin has a secondary function during start-up (initiation of “SAFEBOOT” mode for firmware recovery) and should not normally be held LO during start-up.

By default, the time pulse signal is disabled. For more information, see the u-blox 8 / u-blox M8 Receiver Description / Protocol Specification [2].

1.16 Protocols and interfaces

Protocol	Type
NMEA 0183 V4.0 (V2.1, V2.3 and V4.1 configurable)	Input/output, ASCII
UBX	Input/output, binary, u-blox proprietary
RTCM	Input, messages 1, 2, 3, 9

Figure 5: Available protocols

All protocols are available on UART, USB, DDC (I2C-compliant) and SPI. For specification of the various protocols, see the u-blox 8 / u-blox M8 Receiver Description / Protocol Specification [2].

1.17 Interfaces

A number of interfaces are provided either for data communication or memory access. The embedded firmware uses these interfaces according to their respective protocol specifications.

1.17.1 UART

The NEO-M8L-05B module includes one UART interface, which can be used for communication to a host. It supports configurable baud rates. For the supported baud rates, see the u-blox 8 / u-blox M8 Receiver Description / Protocol Specification [2].

 Designs must allow access to the UART and the **SAFEBOOT_N** function pin for future service, updates and reconfiguration.

1.17.2 USB

A USB interface, which is compatible with USB version 2.0 FS (Full Speed, 12 Mbit/s), can be used for communication as an alternative to the UART. The pull-up resistor on pin **USB_DP** is integrated to signal a full-speed device to the host. The **VDD_USB** pin supplies the USB interface. The u-blox USB (CDC-ACM) driver supports Windows Vista and Windows 7 and 8 operating systems. A separate driver (CDC-ACM) is not required for Windows 10, which has a built-in USB-serial driver. However, the first plugging into an internet-connected Windows 10 PC will trigger the download of the u-blox combined sensor and VCP driver package.

USB drivers can be downloaded from the u-blox web site, www.u-blox.com.

1.17.3 SPI

The SPI interface is designed to allow communication to a host CPU. The interface can be operated in slave mode only. The maximum transfer rate using SPI is 125 kB/s and the maximum SPI clock frequency is 5.5 MHz, see Figure 14. Note that SPI is not available in the default configuration because

its pins are shared with the UART and DDC interfaces. The SPI interface can be enabled by connecting **D_SEL** (pin 2) to ground (see section 3.1).

1.17.4 Display Data Channel (DDC)

An I2C-compliant DDC interface is available for communication with an external host CPU or u-blox cellular modules. The interface can be operated in slave mode only. The DDC protocol and electrical interface are fully compatible with Fast-Mode of the I2C industry standard. Since the maximum SCL clock frequency is 400 kHz, the maximum transfer rate is 400 kb/s.

1.17.5 WHEELTICK (Speed-pulse) and FWD (Forward/reverse) indication



The NEO-M8L-05B module provides a pair of inputs for a hardware speed-pulse and direction (forward/reverse) indication.

The wheel tick input, also known as the HW interface, is used to provide speed pulse (wheel tick) information to the NEO-M8L-05B module. By default, the wheel tick count is based on the rising edge of the wheel tick pulse signal. To improve performance with lower rate, mechanically-derived wheel tick signals, the receiver may be configured to use both the rising and falling edges of the wheel tick signal on the condition that the wheel tick pulses have approximately a 1:1 mark to space ratio regardless of speed. The minimum recommended pulse width is 10 μ s.

The pulse interval (WT resolution) should be less than 40 cm per tick over distance traveled. For best performance, less than 2 cm/tick is recommended. The wheel tick pulse output shall change linearly with the change in speed (navigation filter estimates only the linear scale factor). If the vehicle is standing still, there should be no wheel tick pulses. This is particularly important at system shut-down and power-up. If there is a dead-band (wheel tick pulse does not change or is not output below a certain speed), the performance will be affected at low speed.

If the speed pulse is available from the host processor, the information can also be provided by the SW interface using the UBX-ESF-MEAS message. In this particular case, the wheel tick pin can be configured as EXTINT1 and used to provide a time mark for the message. For more information, see the u-blox 8 / u-blox M8 Receiver Description / Protocol Specification [2].

The forward/reverse input is used to indicate the moving direction by an external signal (HW interface). By default, the wheel tick direction pin polarity is automatically initialized once the vehicle has reached the required minimum speed of 30 km/h. The forward/reverse input polarity can also be set manually. If the forward/reverse information is available from the host processor, the UBX-ESF-MEAS message can also be used to provide the direction of motion (SW interface). For more information, see the u-blox 8 / u-blox M8 Receiver Description / Protocol Specification [2].

-  Do not exceed the maximum voltage of 3.6 V at the input when using the HW interface. When using a SW interface, this pin is not used and can be left open.
-  No forward or reverse input will cause incorrect operation.

1.18 Clock generation

1.18.1 Oscillators

The NEO-M8L-05B GNSS module uses a crystal-based oscillator.

1.18.2 Real-time clock (RTC)

The RTC can be maintained by a secondary 32 kHz oscillator using an RTC crystal. If the main supply voltage is removed, a battery connected to **V_BCKP** allows the RTC to continue to run with very low power consumption. The same supply also maintains a static back-up memory for the current configuration information, recent ephemeris, location and auxiliary data necessary to ensure the fastest re-acquisition when the primary power supply is restored.

 Dead-reckoning before the first GNSS fix requires that the RTC has been enabled and powered on since the previous fix.

1.19 Power management

u-blox M8 technology offers a power-optimized architecture with built-in autonomous power-saving functions to minimize power consumption at any given time. In addition, a high-efficiency DC/DC converter is integrated for lower power consumption and reduced dissipation.

 For more details, see the u-blox 8 / u-blox M8 Receiver Description / Protocol Specification [2].

1.19.1 Power control

A separate battery backup voltage may be applied to the module to retain the current state of the receiver and sustain a low-power real time clock (RTC) when the main supply is removed. This enables fast acquisition and navigation based on dead reckoning before the first GNSS-based fix.

Alternatively, a configuration command (UBX-CFG-PWR) can be issued to stop the receiver in a similar way to hardware backup mode (see 1.18.2 above) while the main supply remains active. This mode is referred to as software backup mode; current consumption in this mode is slightly higher than in the hardware backup mode. The receiver will then restart on the next edge received at its UART interface (there will be a delay before any communications are possible). See Figure 11 for current consumption in backup modes.

1.20 Antenna

To achieve the best performance, u-blox recommends using an active antenna¹³ or an external LNA with this module.

Parameter	Specification	
Antenna type	Active or passive antenna	
Active antenna recommendations	Minimum gain	15 dB (to compensate signal loss in RF cable)
	Maximum gain	50 dB ¹⁴
	Maximum noise figure	1.5 dB

Figure 6: Antenna specifications for the NEO-M8L-05B module

To ensure adequate protection from nearby transmitters, the antenna system should include filtering. Select antennas placed closed to cellular or Wi-Fi transmitting antennas carefully.

 For guidance on antenna selection, see the NEO-M8L Hardware integration manual [1].

¹³ For information on using active antennas with NEO-M8L modules, see the *NEO-M8L Hardware Integration Manual* **Error! Reference source not found..**

¹⁴ Gain above 20 dB should be avoided unless interference in the band 1463 MHz to 1710 MHz is adequately controlled.

2 Pin definition

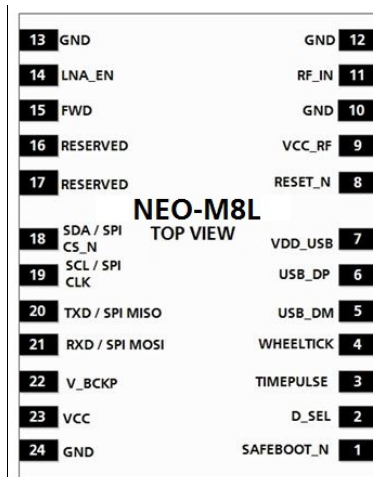

Figure 7: Pin assignment

2.1 Pin assignment

No	Name	I/O	Description
1	SAFEBOOT_N	I	SAFEBOOT_N, test-point for service use (leave OPEN)
2	D_SEL	I	Interface select
3	TIMEPULSE	I/O	Time pulse (disabled by default), do not pull low during reset. Note: configured using TIMEPULSE2 messages (see section 1.15).
4	WHEELTICK	I	Wheel tick input
5	USB_DM	I/O	USB data
6	USB_DP	I/O	USB data
7	VDD_USB	I	USB supply
8	RESET_N	I	RESET_N
9	VCC_RF	O	Output voltage RF section
10	GND	I	Ground
11	RF_IN	I	GNSS signal input
12	GND	I	Ground
13	GND	I	Ground
14	LNA_EN	O	Antenna control
15	FWD	I	Forward/reverse input for speed pulse
16	RESERVED	-	Do not connect
17	RESERVED	-	Do not connect
18	SDA / SPI CS_N	I/O	DDC data if D_SEL = 1 (or open) SPI chip select if D_SEL = 0
19	SCL / SPI CLK	I/O	DDC clock if D_SEL = 1 (or open) SPI clock if D_SEL = 0
20	TXD / SPI MISO	O	Serial port if D_SEL = 1 (or open) SPI MISO if D_SEL = 0
21	RXD / SPI MOSI	I	Serial port if D_SEL = 1 (or open) SPI MOSI if D_SEL = 0
22	V_BCKP	I	Backup voltage supply
23	VCC	I	Supply voltage
24	GND	I	Ground

Figure 8: Pinout of NEO-M8L-05B

3 Configuration management

Configuration settings can be modified with UBX configuration messages. The modified settings remain effective until power-down or reset. Settings can also be saved in battery-backed RAM, flash, or both using the UBX-CFG-CFG message. If settings have been stored in battery-backed RAM, the modified configuration will be retained as long as the backup battery supply is not interrupted. Settings stored in the flash memory will remain effective even after power-down and do not require backup battery supply.



3.1 Interface selection (D_SEL)

At startup, Pin 2 (**D_SEL**) determines which data interfaces are used for communication. If **D_SEL** is set high or left open, UART and DDC become available. If **D_SEL** is set low, that is, connected to ground, the NEO-M8L-05B module can communicate to a host via SPI.

PIN #	D_SEL="1" (left open)	D_SEL="0" (connected to GND)
20	UART TX	SPI MISO
21	UART RX	SPI MOSI
19	DDC SCL	SPI CLK
18	DDC SDA	SPI CS_N

Figure 9: Data interface selection by D_SEL

4 Electrical specification

-  The limiting values given are in accordance with the Absolute Maximum Rating System (IEC 134). Stress above one or more of the limiting values may cause permanent damage to the device. These are stress ratings only and operation of the device at these or at any other conditions above those given in the characteristics sections of the specification is not implied. Exposure to these limits for extended periods may affect device reliability.
-  Where application information is given, it is advisory only and does not form part of the specification. For more information see the NEO-M8L Hardware integration manual [1].

4.1 Absolute maximum rating

Parameter	Symbol	Condition	Min	Max	Units
Power supply voltage	VCC, VCC_IO		-0.5	3.6	V
Backup battery voltage	V_BCKP		-0.5	3.6	V
USB supply voltage	VDD_USB		-0.5	3.6	V
Input pin applied DC voltage	Vin		-0.5	VCC+0.5	V
	Vin_usb		-0.5	VDD_USB	V
	Vrfin		0	6	V
DC current through any digital I/O pin (except supplies)	Ipin			10	mA
VCC_RF output current	ICC_RF			100	mA
Input power at RF_IN	Prfin	source impedance = 50 Ω, continuous wave		15	dBm
Storage temperature	Tstg		-40	+85	°C

Figure 10: Absolute maximum ratings

-  Stressing the device beyond the “Absolute Maximum Ratings” may cause permanent damage. These are stress ratings only. The product is not protected against overvoltage or reversed voltages. If necessary, voltage spikes exceeding the power supply voltage specification, given in Figure 10, must be limited to values within the specified boundaries by using appropriate protection diodes.

4.2 Operating conditions

All specifications are at an ambient temperature of 25°C. Extreme operating temperatures can significantly impact the specification values. Applications operating near the temperature limits should be tested to ensure the specification.

Parameter	Symbol	Min	Typical	Max	Units	Condition
Power supply voltage	VCC	2.7	3.0	3.6	V	
Supply voltage USB	VDD_USB	3.0	3.3	3.6	V	
Backup battery voltage	V_BCKP	1.4		3.6	V	
Backup battery current	I_BCKP		15		μA	V_BCKP = 1.8 V, VCC = 0 V
SW backup current	I_SWBCKP		30		μA	VCC = 3 V
Input pin voltage range	V _{in}	0		VCC	V	
Digital IO Pin Low level input voltage	V _{il}	0		0.2*VCC	V	
Digital IO Pin High level input voltage	V _{ih}	0.7*VCC		VCC	V	
Digital IO Pin Low level output voltage	V _{ol}			0.4	V	I _{ol} = 4 mA
Digital IO Pin High level output voltage	V _{oh}	VCC-0.4			V	I _{oh} = 4 mA
Pull-up resistor for RESET_N (internal)	R _{pu}		11		kΩ	
USB_DM, USB_DP	V _{inU}	Compatible with USB with 27 Ω series resistance				
VCC_RF voltage	VCC_RF		VCC-0.1		V	
VCC_RF output current	I _{CC_RF}			50	mA	
Receiver Chain Noise Figure ¹⁵	N _{Ftot}		3		dB	
Operating temperature	T _{opr}	-40		+85	°C	

Figure 11: Operating conditions

Operation beyond the specified operating conditions can affect device reliability.

4.3 Indicative current requirements

Figure 12 lists examples of the total system supply current for a possible application.

Values in Figure 12 are provided for customer information only as an example of typical power requirements. Values are characterized on samples, actual power requirements can vary depending on FW version used, external circuitry, number of SVs tracked, signal strength, type of start as well as time, duration and conditions of test.

Parameter	Symbol	Typ. GPS & GLONASS	Typ. GPS / QZSS / SBAS	Max	Units	Condition
Max supply current ¹⁶	I _{ccp}			67	mA	
Average supply current ^{17, 18}	I _{cc} Acquisition ¹⁹	29	23		mA	Estimated at 3 V
	I _{cc} Tracking (Continuous mode)	29	23		mA	Estimated at 3 V

Figure 12: Indicative power requirements at 3.0 V

For more power requirement information, see the NEO-M8L Hardware integration manual [1].

¹⁵ Only valid for the GPS band.

¹⁶ Use this figure to determine maximum current capability of power supply. This is measured with 1 Hz bandwidth.

¹⁷ Use this figure to determine required battery capacity.

¹⁸ Simulated GNSS constellation using power levels of -130 dBm. VCC = 3.0 V.

¹⁹ Average current from start-up until the first fix.

For more information on how to noticeably reduce current consumption, see the Power Management Application Note [4].

4.4 SPI timing diagrams

To avoid incorrect operation of the SPI, the user needs to comply with certain timing conditions. The following signals need to be considered for timing constraints:

Symbol	Description
SPI CS_N (SS_N)	Slave select signal
SPI CLK (SCK)	Slave clock signal

Figure 13: Symbol description

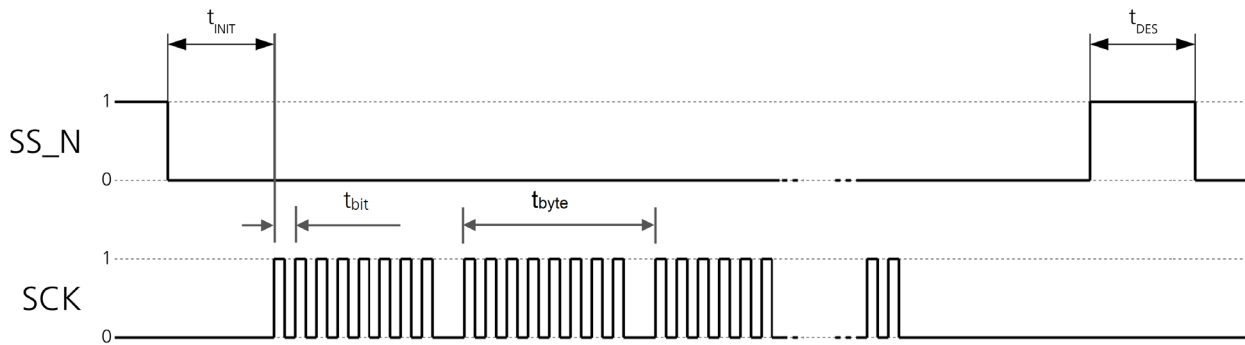

Figure 14: SPI timing diagram

4.4.1 Timing recommendations

The recommendations below are based on a firmware running from the flash memory.

Parameter	Description	Recommendation
t_{INIT}	Minimum initialization time	10 μ s
t_{DES}	Deselect time	1 ms
t_{bit}	Minimum bit time	180 ns (5.5 MHz max bit frequency)
t_{byte}	Minimum byte period	8 μ s (125 kHz max byte frequency)

Figure 15: SPI timing recommendations

The values in Figure 15 result from the requirement of an error-free transmission. By allowing just a few errors and disabling the glitch filter, the bit rate can be increased considerably.

4.5 DDC timing

The DDC interface is I2C Fast Mode-compliant. For timing parameters, consult the I2C standard.

The maximum bit rate is 400 kb/s. The interface stretches the clock when slowed down when serving interrupts, so real bit rates may be slightly lower.

5 Mechanical specifications

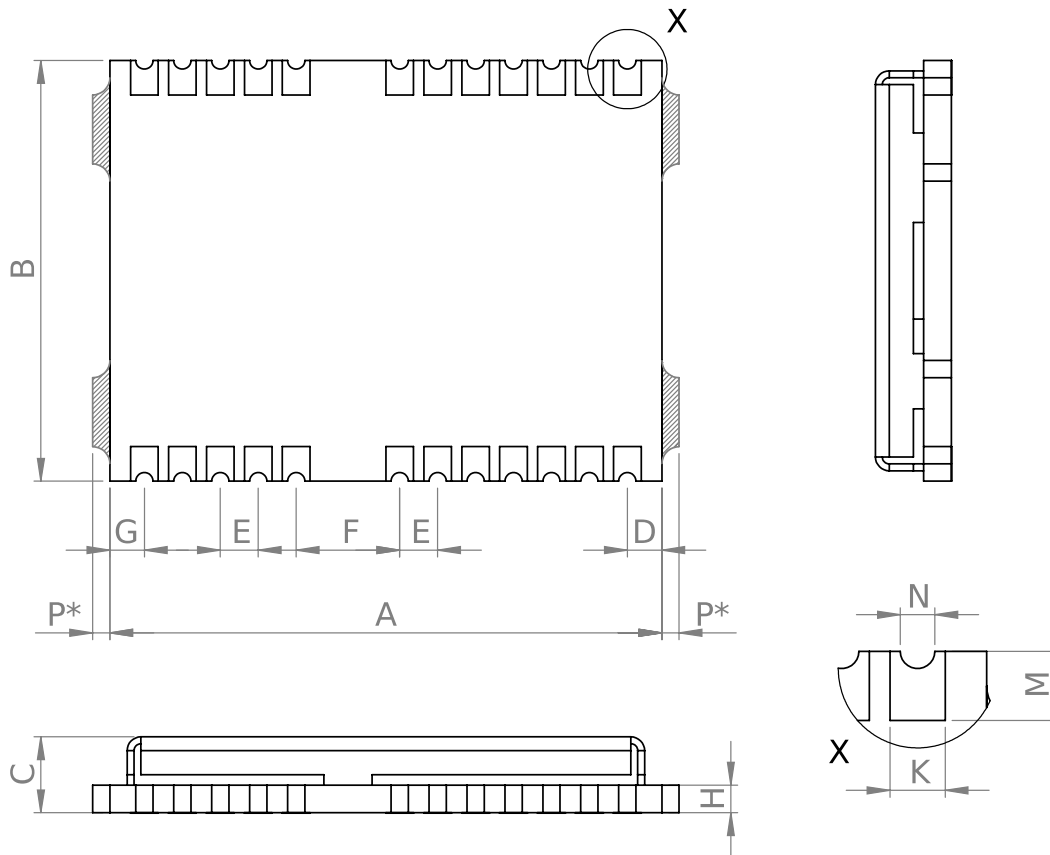





Figure 16 NEO-M8L-05B mechanical drawing

Symbol	Min. [mm]	Typ. [mm]	Max. [mm]	
A	15.9	16.0	16.1	
B	12.1	12.2	12.3	
C	2.2	2.4	2.6	
D	0.9	1.0	1.1	
E	1.0	1.1	1.2	
F	2.9	3.0	3.1	
G	0.9	1.0	1.1	
H	-	0.82	-	
K	0.7	0.8	0.9	
M	0.8	0.9	1.0	
N	0.4	0.5	0.6	
P*	0.0	-	0.5	The de-paneling residual tabs may be on either side (not both).
Weight		1.6 g		

Table 1 NEO-M8L-05B 3D mechanical dimensions

-  The mechanical picture of the de-paneling residual tabs (P*) is an approximate representation. The shape and position of the residual tab may vary.
-  When designing the component keep-out area, note that the de-paneling residual tabs can be on either side of the module (not both).
-  For information about the paste mask and footprint, see the NEO-M8L Hardware integration manual [1].

6 Reliability tests and approvals

6.1 Reliability tests

 The NEO-M8L-05B modules are based on AEC-Q100 qualified GNSS chips.

Tests for product family qualifications are according to ISO 16750 "Road vehicles – environmental conditions and testing for electrical and electronic equipment", and appropriate standards.

6.2 Approvals

Products marked with this lead-free symbol on the product label comply with the Directive 2002/95/EC and Directive 2011/65/EU of the European Parliament and the Council on the Restriction of Use of certain Hazardous Substances in Electrical and Electronic Equipment (RoHS).

All u-blox M8 GNSS modules are RoHS-compliant.

7 Product handling and soldering

For more information about packaging, shipping, storage and handling, see the u-blox Package Information Guide [3].

7.1 Packaging

The NEO-M8L-05B GNSS modules are delivered as hermetically sealed, reeled tapes in order to enable efficient production, production lot set-up and tear-down.

7.1.1 Reels

The NEO-M8L-05B modules are deliverable in quantities of 250 pcs on a reel. The NEO-M8L-05B receivers are shipped on Reel Type B.

7.1.2 Tapes

The dimensions and orientations of the tapes for NEO-M8L-05B modules are specified in Figure 17.

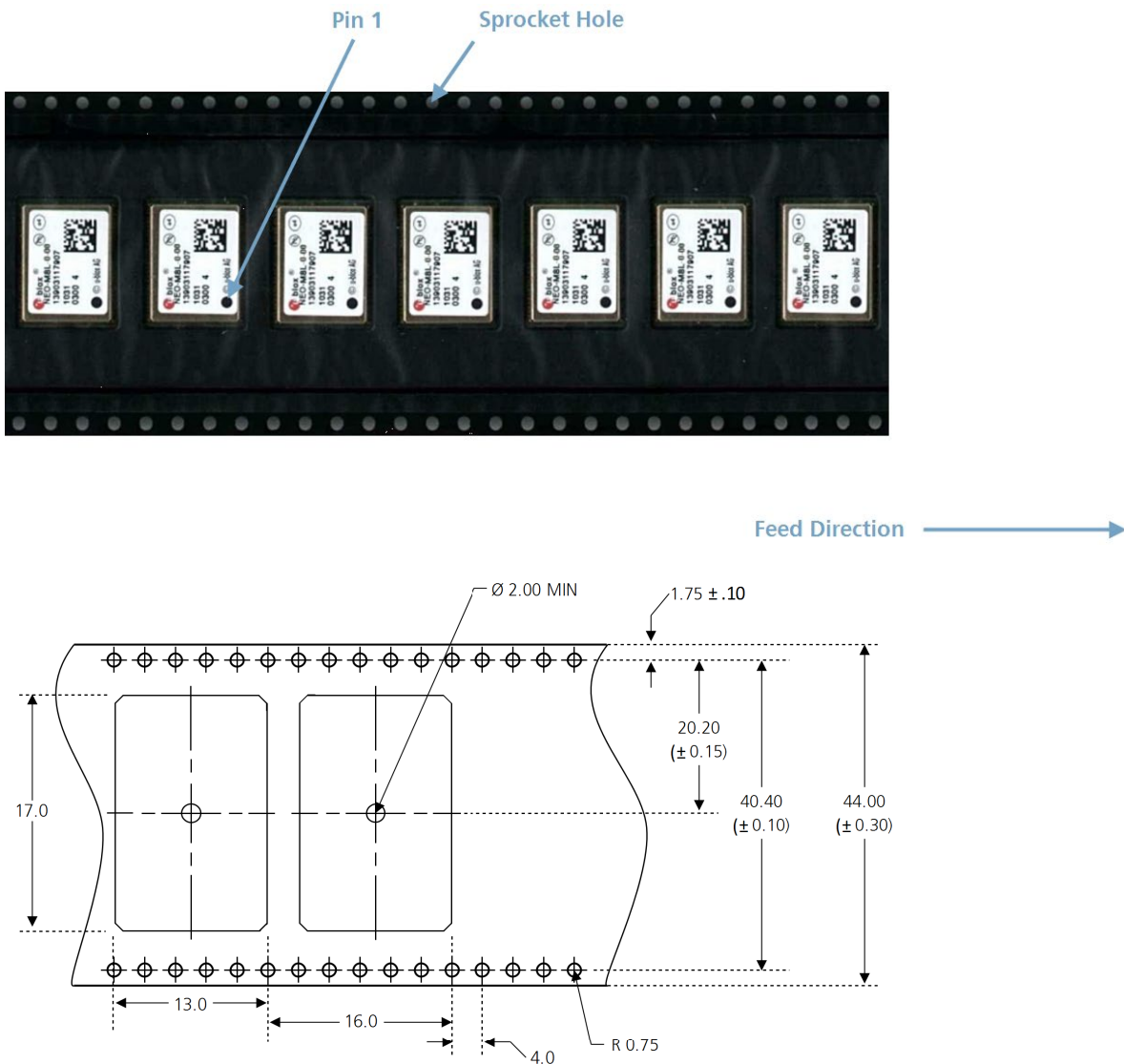

Figure 17: Dimensions and orientation for NEO-M8L-05B modules on tape

7.2 Shipment, storage and handling

The absolute maximum rating of the storage temperature specified in chapter 4.1 apply to the storage of the module both before and after soldering. Required storage conditions for modules in reeled tapes and for naked modules before soldering are described in the u-blox Package Information Guide [3].

7.2.1 Moisture sensitivity levels

The moisture sensitivity level (MSL) relates to the packaging and handling precautions required. NEO-M8L-05B is rated at MSL level 4.

For MSL standard see IPC/JEDEC J-STD-020, which can be downloaded from www.jedec.org.

7.2.2 Reflow soldering

Reflow profiles are to be selected according to u-blox recommendations (see the NEO-M8L Hardware integration manual [1]).

7.2.3 ESD handling precautions

NEO-M8L-05B modules are Electrostatic Sensitive Devices (ESD). Observe precautions for handling! Failure to observe these precautions can result in severe damage to the GNSS receiver!

GNSS receivers are Electrostatic Sensitive Devices (ESD) and require special precautions when handling. Particular care must be exercised when handling patch antennas, due to the risk of electrostatic charges. In addition to standard ESD safety practices, the following measures should be taken into account whenever handling the receiver:

- Unless there is a galvanic coupling between the local GND (i.e. the work desk) and the PCB GND, then the first point of contact when handling the PCB must always be between the local GND and PCB GND.
- Before mounting an antenna patch, connect ground of the device
- When handling the RF pin, do not come into contact with any charged capacitors and be careful when contacting materials that can develop charges (e.g. patch antenna ~10 pF, coax cable ~50-80 pF/m, soldering iron).
- To prevent electrostatic discharge through the RF input, do not touch any exposed antenna area. If there is any risk that such exposed antenna area is touched in a non-ESD protected work area, implement proper ESD protection measures in the design.
- When soldering RF connectors and patch antennas to the receiver's RF pin, make sure to use an ESD safe soldering iron (tip).

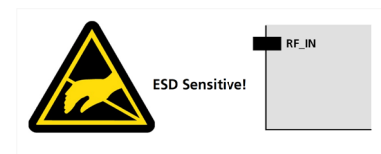

8 Default messages

Interface	Settings
UART Output	9600 baud, 8 bits, no parity bit, 1 stop bit. Configured to transmit both NMEA and UBX protocols, but only the following NMEA (and no UBX) messages have been activated at start-up: GGA, GLL, GSA, GSV, RMC, VTG, TXT.
USB Output	Configured to transmit both NMEA and UBX protocols, but only the following NMEA (and no UBX) messages have been activated at start-up: GGA, GLL, GSA, GSV, RMC, VTG, TXT. USB power mode: Bus powered.
UART Input	9600 baud, 8 bits, no parity bit, 1 stop bit, Autobauding disabled. Automatically accepts following protocols without need of explicit configuration: UBX, NMEA, RTCM. The GNSS receiver supports interleaved UBX and NMEA messages.
USB Input	Automatically accepts following protocols without need of explicit configuration: UBX, NMEA. The GPS receiver supports interleaved UBX and NMEA messages. USB power mode: Bus powered.
DDC	Fully compatible with the I2C industry standard, available for communication with an external host CPU or u-blox cellular modules, operated in slave mode only. Default messages activated. NMEA and UBX are enabled as input messages, only NMEA as output messages. Maximum bit rate 400 kb/s.
SPI	Allow communication to a host CPU, operated in slave mode only. Default messages activated. SPI is not available in the default configuration.
TIMEPULSE	Disabled

Figure 18: Default messages

 Refer to the u-blox 8 / u-blox M8 Receiver Description / Protocol Specification [2] for information about further settings.

9 Labeling and ordering information

9.1 Product labeling

The labeling of u-blox M8 GNSS modules includes important product information. The location of the product type number is shown in Figure 19.

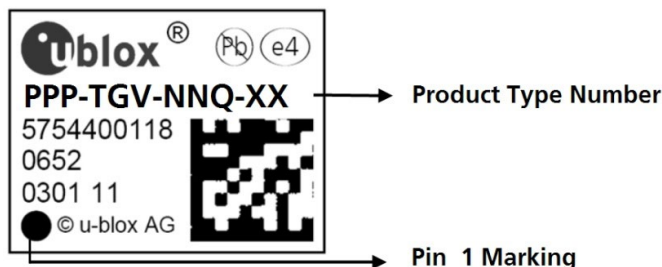

Figure 19: Location of product type number on the u-blox NEO-M8L-05B module label (Professional grade)

9.2 Explanation of codes

Three different product code formats are used. The **Product Name** is used in documentation such as this data sheet and identifies all u-blox M8 products, independent of packaging and quality grade. The **Ordering Code** includes options and quality, while the **Type Number** includes the hardware and firmware versions. Figure 20 shows the structure of these three different formats.

Format	Structure
Product Name	PPP-TGV
Ordering Code	PPP-TGV-NNQ (Professional grade)
Type Number	PPP-TGV-NNQ-XX (Professional grade)

Figure 20: Product code formats

The parts of the product code are explained in Figure 21.

Code	Meaning	Example
PPP	Product family	NEO
TG	Platform	M8 = u-blox M8
V	Variant	Function set (A-Z), T = Timing, L = ADR, etc.
NNQ	Option / Quality grade	Describes standardized functional element and quality grade NN: Option [00 ...99] Q: Grade A = Automotive B = Professional
XX	Product detail	Describes product details or options such as hard- and software revision, cable length, etc.

Figure 21: Parts of the identification code

9.3 Ordering codes

Ordering no.	Product
NEO-M8L-05B	u-blox M8 GNSS LCC module with 3D dead reckoning and on-board sensors, 12.2 x 16 mm, 250 pcs/reel, Professional grade

Figure 22: Product ordering codes for NEO-M8L-05B module

Product changes affecting form, fit or function are documented by u-blox. For a list of Product Change Notifications (PCNs), see our website.

Appendix

A Glossary

Abbreviation	Definition
ADR	Automotive Dead Reckoning
BEIDOU	Chinese satellite navigation system
EMC	Electromagnetic compatibility
EMI	Electromagnetic interference
EOS	Electrical Overstress
EPA	Electrostatic Protective Area
ESD	Electrostatic discharge
GALILEO	European Navigation satellite system
GLONASS	Russian satellite system
GND	Ground
GNSS	Global Navigation Satellite System
GPS	Global Positioning System
GSM	Global System for Mobile Communications
IEC	International Electrotechnical Commission
PCB	Printed circuit board
QZSS	Quasi-Zenith Satellite System
ROHS	Directive 2002/95/EC of the European Parliament and the Council on the Restriction of Use of certain Hazardous Substances in Electrical and Electronic Equipment
SENSOR FUSION	Addition of sensors to GNSS navigation solution to increase accuracy
V2V	Vehicle-to-Vehicle

Figure 23: Explanation of the abbreviations and terms used

Related documents

- [1] NEO-M8L (ADR4) Hardware integration manual, [UBX-16010549](#)
- [2] u-blox 8 / u-blox M8 Receiver Description including Protocol Specification (NDA version), UBX 13002887
- [3] u-blox Package Information Guide, [UBX-14001652](#)
- [4] Power Management Application Note, [UBX-13005162](#)
- [5] MGA Services User Guide, [UBX-13004360](#)
- [6] Radio Resource LCS Protocol (RRLP), (3GPP TS 44.031 version 11.0.0 Release 11)
- [7] NEO-M8L Product summary, [UBX-16000760](#)
- [8] NEO-M8L, NEO-M8U Information Note, [UBX-20014805](#)

 For regular updates to u-blox documentation and to receive product change notifications, register on our homepage (www.u-blox.com).

Revision history

Revision	Date	Name	Comments
R01	20-Mar-2020	ssid	Advance Information
R02	22-Jun-2020	mala	Early production information. Added information on NEO-M8L, NEO-M8U information note in Document information and Related documents. Disclosure restriction changed to C1-Public.
R03	26-Nov-2020	ssid	Block diagram updated
R04	14-Jan-2021	njaf	Moisture sensitivity level (MSL) updated to 4 in 7.2.1
R05	16-Dec-2022	skar	Chapter Mechanical specifications updated with information on de-paneling residual tabs

Contact

u-blox AG

Address: Zürcherstrasse 68
8800 Thalwil
Switzerland

For further support and contact information, visit us at www.u-blox.com/support.