



LARA-L6 series

Multi-mode LTE Cat 4 modules in smallest form factor

Data sheet



Abstract

LARA-L6 cellular module features uncompromised global connectivity in a very small form factor. The feature-rich LARA-L6 modules have a comprehensive certification scheme, versatile interfaces, and multi-band and multi-mode capabilities, all which make LARA-L6 modules ideally suited for use in any region and in wide range of applications.

Document information

Title	LARA-L6 series	
Subtitle	Multi-mode LTE Cat 4 modules in smallest form factor	
Document type	Data sheet	
Document number	UBX-21047783	
Revision and date	R03	28-Mar-2023
Disclosure restriction	C1-Public	

Product status	Corresponding content status	
Functional sample	Draft	For functional testing. Revised and supplementary data will be published later.
In development / Prototype	Objective specification	Target values. Revised and supplementary data will be published later.
Engineering sample	Advance information	Data based on early testing. Revised and supplementary data will be published later.
Initial production	Early production information	Data from product verification. Revised and supplementary data may be published later.
Mass production / End of life	Production information	Document contains the final product specification.

This document applies to the following products:

Product name	Type number	Modem version	Application version	PCN reference	Product status
LARA-L6004	LARA-L6004-00B-00	03.16	A00.01	UBX-23003246	Mass production
	LARA-L6004-01B-00	N/A	N/A	N/A	Functional sample
LARA-L6004D	LARA-L6004D-00B-00	03.16	A00.01	UBX-23003246	Mass production
	LARA-L6004D-01B-00	N/A	N/A	N/A	Functional sample
LARA-L6804D	LARA-L6804D-01B-00	N/A	N/A	N/A	Functional sample

u-blox or third parties may hold intellectual property rights in the products, names, logos and designs included in this document. Copying, reproduction, modification or disclosure to third parties of this document or any part thereof is only permitted with the express written permission of u-blox.

The information contained herein is provided "as is" and u-blox assumes no liability for its use. No warranty, either express or implied, is given, including but not limited to, with respect to the accuracy, correctness, reliability and fitness for a particular purpose of the information. This document may be revised by u-blox at any time without notice. For the most recent documents, visit www.u-blox.com.

Copyright © u-blox AG.

Contents

Document information	2
Contents	3
1 Functional description	5
1.1 Overview.....	5
1.2 Product features.....	5
1.3 Block diagram.....	6
1.4 Product description.....	6
1.5 AT command support.....	7
1.6 Supported features.....	8
2 Interfaces	10
2.1 Power management.....	10
2.1.1 Module supply input (VCC).....	10
2.1.2 Generic digital interfaces supply output (V_INT).....	10
2.2 Antenna interfaces.....	10
2.2.1 Antenna RF interfaces.....	10
2.2.2 Antenna detection.....	10
2.3 System functions.....	10
2.3.1 Module power-on.....	10
2.3.2 Module power-off.....	11
2.3.3 Module reset.....	11
2.4 SIM interface.....	11
2.4.1 SIM card / chip interface.....	11
2.4.2 SIM card detection.....	12
2.5 Serial communication.....	12
2.5.1 UART interfaces.....	12
2.5.2 USB interface.....	13
2.5.3 I2C interface.....	13
2.6 Audio interface.....	14
2.7 Clock output.....	14
2.8 GPIO pins.....	14
2.9 Antenna dynamic tuner interface.....	15
2.10 Reserved pins.....	15
3 Pin definition	16
3.1 Pin assignment.....	16
4 Electrical specifications	20
4.1 Absolute maximum rating.....	20
4.1.1 Maximum ESD.....	20
4.2 Operating conditions.....	21
4.2.1 Operating temperature range.....	21
4.2.2 Thermal parameters.....	21

4.2.3	Supply/power pins	21
4.2.4	Current consumption	22
4.2.5	LTE RF characteristics	23
4.2.6	3G RF characteristics	25
4.2.7	2G RF characteristics	25
4.2.8	ANT_DET pin.....	26
4.2.9	PWR_ON pin.....	26
4.2.10	RESET_N pin.....	26
4.2.11	SIM pins	27
4.2.12	USB pins	27
4.2.13	I2C pins	27
4.2.14	Generic Digital Interfaces pins	28
4.2.15	Smart temperature supervisor	29
4.3	Parameters for ATEX applications	29
5	Mechanical specifications	30
6	Qualification and approvals.....	31
6.1	Reliability tests	31
6.2	Approvals.....	31
7	Product handling & soldering.....	32
7.1	Packaging	32
7.1.1	Reels	32
7.1.2	Tapes.....	32
7.2	Moisture sensitivity levels.....	33
7.3	Reflow soldering	33
7.4	ESD precautions.....	33
8	Labeling and ordering information	34
8.1	Product labeling.....	34
8.2	Explanation of codes	34
8.3	Ordering information.....	35
Appendix	36
A	Glossary	36
Related documentation	38
Revision history	38
Contact	39

1 Functional description

1.1 Overview

The LARA-L6 series comprises multi-band and multi-mode modules supporting LTE Cat 4 FDD and LTE Cat 4 TDD radio access technology (RAT), with 3G UMTS/HSPA and 2G GSM/GPRS/EGPRS fallback, providing the ideal solution for global and multi-regional coverage in the small LARA LGA form-factor (26.0 x 24.0 mm, 100-pin), which is easy to integrate in compact designs.

With three product variants: the LARA-L6004 voice and data module and LARA-L6004D data-only module, both with global coverage, and the LARA-L6804D data-only module designed with multi-regional coverage for EMEA, APAC, Japan and Latin America regions, customers have great flexibility, can maximize reusing their development efforts, and can simplify logistics.

Versatile interfaces, features, multi-band and multi-mode capabilities make the LARA-L6 series modules ideally suitable for a wide range of applications, such as asset tracking, telematics, remote monitoring, alarm panels, video surveillance, connected health, point of sales terminals, and mobile cameras. Generally, the modules are suited to applications that require high speed data, seamless connectivity, superior coverage, low latency, streaming services, and to industrial applications focused on product life-cycle longevity.

1.2 Product features

Model	Region	Radio Access Technology	GNSS	u-blox services	Interfaces	Features	Grade
		LTE Category LTE FDD bands LTE TDD bands UMTS/HSPA FDD bands GSM/GPRS/EGPRS bands	Internal GNSS receiver External GNSS control via modem	IoT Security -as-a-Service MQTT Anywhere /MQTT Flex AssistNow software CellLocate®	UART USB 2.0 I2C GPIOs Digital audio	Root of Trust Secure boot / update Embedded MQTT / MQTT-SN TCP/IP, UDP/IP, HTTP/FTP TLS/DTLS Dual stack IPv4 /IPv6 FOAT / uFOOTA LwM2M 3GPP Power Saving Mode eDRX Last gasp Jamming detection Antenna and SIM detection Antenna dynamic tuning Rx Diversity / Rx MIMO 2x2 VoLTE/CSFB	Standard Professional Automotive
LARA-L6004	Global	1,2,3,4,5,7,8 4 12,13,18,19 20,26,28 38,39 1,2 40,41 5,8 Quad	●	● ●	2 1 1 9 ●	● ● ● ● ● ● ● ● ● ● ● ● ● ● ● ●	●
LARA-L6004D	Global	1,2,3,4,5,7,8 4 12,13,18,19 20,26,28 38,39 1,2 40,41 5,8 Quad	●	● ●	2 1 1 9	● ● ● ● ● ● ● ● ● ● ● ● ● ● ● ●	●
LARA-L6804D	Multi-Region	1,2,3,4,5,7,8 4 18,19 20,26,28 1,2 5,8 Quad	■	■ ■	2 1 1 9	■ ■ ■ ■ ■ ■ ■ ■ ■ ■ ■ ■ ■ ■ ■ ■	■

● = "00B", "01B" and future product versions

■ = "01B" and future product versions

Table 1: LARA-L6 series main features summary

1.3 Block diagram

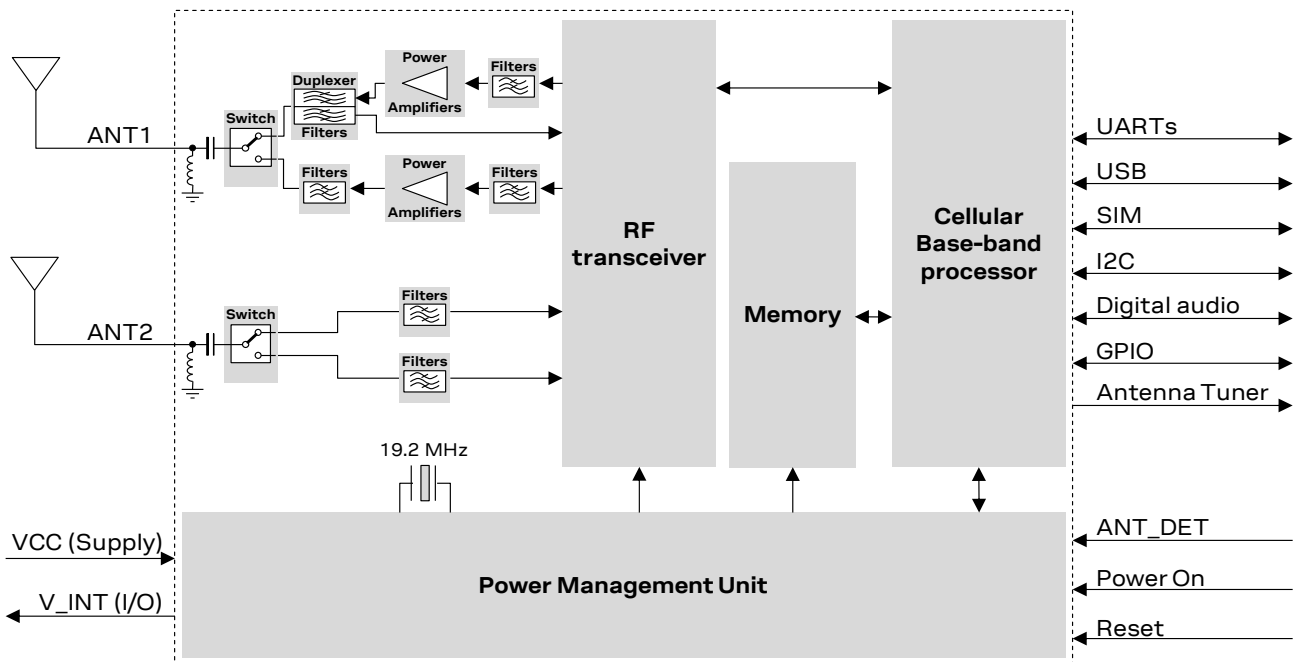



Figure 1: LARA-L6 series block diagram

-  The digital audio interface is not supported by LARA-L6004D / LARA-L6804D data-only modules.
-  The antenna tuner interface is not supported by the LARA-L6004-00B and LARA-L6004D-00B product versions. The corresponding pins are marked as reserved for future use (**RSVD**), they are intended to be left unconnected and they should not be driven by external devices.

1.4 Product description

LARA-L6 series modules include three variants providing flexibility to use the bands and the RAT available in specific region or with specific operators:

- The LARA-L6004 data and voice modules and the LARA-L6004D data-only modules are the smallest LTE Cat 4 multi-mode modules for global coverage, providing universal connectivity and simplifying production logistics. These are truly global modules with comprehensive band support including 18 LTE bands plus 3G/2G fallback.
- The LARA-L6804D data-only modules are a multi-regional variant specifically designed for use in EMEA, APAC, Japan and Latin America regions. They support all relevant LTE Cat 4 bands plus 3G/2G fallback.

Except for the LARA-L6004D and LARA-L6804D data-only product versions, the LARA-L6 series modules provide Voice over LTE (VoLTE) and Circuit-Switched-Fall-Back (CSFB) audio capability according to the supported RAT. The 911 and E911 services are not supported.

4G LTE	3G UMTS/HSDPA/HSUPA	2G GSM/GPRS/EDGE
3GPP Release 10	3GPP Release 9	3GPP Release 9
Long Term Evolution (LTE)	High Speed Packet Access (HSPA)	Enhanced Data rate GSM Evolution (EDGE)
Evolved UTRA (E-UTRA)	UMTS Terrestrial Radio Access (UTRA)	GSM EGPRS Radio Access (GERA)
Frequency/Time Division Duplex (FDD/TDD)	Frequency Division Duplex (FDD)	Time Division Multiple Access (TDMA)
DL Multi-Input Multi-Output (MIMO) 2x2	DL Rx Diversity	DL Advanced Rx Performance Phase 1
LTE Power Class	UMTS/HSDPA/HSUPA Power Class	GSM/GPRS (GMSK) Power Class
<ul style="list-style-type: none"> Power Class 3 (23 dBm) 	<ul style="list-style-type: none"> Class 3 (24 dBm) 	<ul style="list-style-type: none"> Class 4 (33 dBm) for 850/900 band Class 1 (30 dBm) for 1800/1900 band EDGE (8-PSK) Power Class <ul style="list-style-type: none"> Class E2 (27 dBm) for 850/900 band Class E2 (26 dBm) for 1800/1900 band
Data rate	Data rate	Data rate
<ul style="list-style-type: none"> LTE category 4: up to 150 Mbit/s DL, up to 50 Mbit/s UL 	<ul style="list-style-type: none"> HSDPA category 24: up to 42.2 Mbit/s DL HSUPA category 6: up to 5.76 Mbit/s UL 	<ul style="list-style-type: none"> GPRS multi-slot class 33¹, CS1-CS4, up to 107 kbit/s DL, 85.6 kbit/s UL EDGE multi-slot class 33¹, MCS1-MCS9, up to 296 kbit/s DL, 236.8 kbit/s UL

Table 2: LARA-L6 series LTE, 3G and 2G characteristics summary

Module	Region	LTE FDD bands ²	LTE TDD bands ²	WCDMA bands	GSM bands
LARA-L6004, LARA-L6004D	Global	12 (700 MHz)	39 (1900 MHz)	5 (850 MHz)	GSM 850
		28 (700 MHz)	40 (2300 MHz)	8 (900 MHz)	E-GSM 900
		13 (700 MHz)	41 (2600 MHz)	2 (1900 MHz)	DCS 1800
		20 (800 MHz)	38 (2600 MHz)	1 (2100 MHz)	PCS 1900
		18 (850 MHz)			
		19 (850 MHz)			
		26 (850 MHz)			
		5 (850 MHz)			
		8 (900 MHz)			
		4 (1700 MHz)			
		3 (1800 MHz)			
		2 (1900 MHz)			
1 (2100 MHz)					
7 (2600 MHz)					
LARA-L6804D	Europe, Middle East, Africa, Asia-Pacific, Japan, Latin America	28 (700 MHz)		5 (850 MHz)	GSM 850
		20 (800 MHz)		8 (900 MHz)	E-GSM 900
		18 (850 MHz)		2 (1900 MHz)	DCS 1800
		19 (850 MHz)		1 (2100 MHz)	PCS 1900
		26 (850 MHz)			
		5 (850 MHz)			
		8 (900 MHz)			
		4 (1700 MHz)			
		3 (1800 MHz)			
		2 (1900 MHz)			
		1 (2100 MHz)			
		7 (2600 MHz)			

Table 3: LARA-L6 series supported LTE, 3G and 2G bands summary

1.5 AT command support

The LARA-L6 series modules support AT commands according to 3GPP standards TS 27.007 [8], TS 27.005 [9] and the u-blox AT command extension.



For a complete list of supported AT commands, see the AT commands manual [1].

¹ GPRS/EDGE multislot class 33 implies a maximum of 5 slots in DL (reception), 4 slots in UL (transmission) with 6 slots in total.

² LARA-L6 modules support all E-UTRA channel bandwidths for each operating band according to 3GPP TS 36.521-1 [11].

RIL (Radio Interface Layer) software for Android is available free of charge, See the Android RIL source code application note [3] for the supported software deliveries and more information.

1.6 Supported features

Table 4 lists the main features supported by LARA-L6 series modules. For more details, see the AT commands manual [1].

Feature	Description
Device security	Device security features include: <ul style="list-style-type: none"> Secure boot: software authenticity and integrity Secure update: secure delivery of the correct FW to the module
u-blox Firmware update Over The Air (uFOTA)	u-blox firmware update over the air interface client/server solution using LwM2M.
Firmware update Over AT commands (FOAT)	Firmware update over AT command interfaces.
VoLTE and CSFB audio capability ³	Voice over LTE (VoLTE) feature allows voice service over LTE bearer, via embedded IP Multimedia Subsystem (IMS). Circuit Switched Fall-Back (CSFB) feature allows voice service over circuit switched infrastructure (3G or 2G radio access technologies).
LTE Rx MIMO 2x2 / 3G Rx Diversity	Improved cellular link quality and reliability on all operating bands, by 2 receiving antenna.
Network indication	GPIO configured to indicate the network status: registered home network, registered roaming, voice or data call enabled, or no service. The feature can be enabled by the +UGPIOC AT command.
Antenna detection	The ANT_DET pin provides antenna presence detection capability, as optional features, evaluating the resistance from ANT1 and ANT2 pins to GND by an external antenna detection circuit implemented on the application board.
Antenna dynamic tuning ⁴	Control of an external antenna matching IC via two GPIOs changing dynamically the high/low state in real time according to the cellular band used by the module.
Jamming detection	Detects “artificial” interference that obscures the operator’s carriers entitled to give access to the radio service and reports the start and stop of such conditions to the application processor that can react accordingly.
LwM2M	The LwM2M is a light and compact communication protocol designed for managing IoT machine-to-machine communication between a LwM2M server and a LwM2M client located in lightweight, low power or resource-constrained LwM2M devices, with object data model.
DNS	Support for DNS functionality.
IPv4/IPv6 dual-stack	Capability to move between IPv4 and dual stack network infrastructures. IPv4 and IPv6 addresses can be used.
PPP	IPv4/IPv6 packets relaying through the cellular protocol stack performed on a Point-to-Point Protocol (PPP) connection established with the external application via a serial interface. Transitions between Online command mode (OLCM) and PPP mode are supported.
Multiple PDP contexts	Multiple PDP contexts can be activated, and multi secondary PDP contexts be associated to a primary PDP context.
BIP	Bearer Independent Protocol (BIP) for Over-the-Air SIM provisioning. The data transfer to/from the SIM uses either an already active PDP context or a new PDP context established with the APN provided by the SIM card.
External u-blox GNSS control via modem	Access to u-blox positioning chips and modules is available through a dedicated I2C interface. This means that from any host processor, a single serial port can control the cellular module and the u-blox positioning chip or module.
Embedded AssistNow software	Embedded AssistNow Online and AssistNow Offline clients are available to provide better GNSS performance and faster Time-to-First-Fix. An AT command can enable / disable the clients.

³ Not supported by LARA-L6004D and LARA-L6804D data-only modules

⁴ Not supported by LARA-L6004-00B and LARA-L6004D-00B product versions

Feature	Description
CellLocate®	<p>Enables the estimation of device position based on the parameters of the mobile network cells visible to the specific device based on the CellLocate® database</p> <p>A set of AT commands allows CellLocate® service configuration and position request.</p> <p> u-blox is extremely mindful of user privacy. When a position is sent to the CellLocate® server, u-blox is unable to track the SIM used or the specific device.</p>
Hybrid positioning	<p>The current module position is provided by a u-blox positioning chip or module or the estimated position from CellLocate® depending on which method provides the best and fastest solution according to the user configuration.</p> <p>A set of AT commands allows Hybrid positioning service configuration and position request.</p>
Smart Temperature Supervisor	<p>Constant monitoring of the module board temperature:</p> <ul style="list-style-type: none"> • Warning notification when the temperature approaches an upper or lower predefined threshold • Shutdown notified and forced when the temperature value is outside the specified range (shutdown suspended in case of an emergency call in progress) <p>The optional Smart Temperature Supervisor feature is by default disabled, and it can be enabled and configured through the +USTS AT command.</p> <p> The sensor measures the board temperature, which can differ from ambient temperature.</p>
Last gasp	<p>In case of power supply outage the cellular module can be configured through the +ULGASP AT command to send an alarm notification to a remote entity.</p>
Low power idle mode	<p>The power saving configuration is disabled by default, but it can be enabled and configured using the +UPSV AT command. When the power saving is enabled, the module automatically enters the low power idle mode whenever possible, reducing current consumption.</p>
Fast Dormancy	<p>The Fast Dormancy feature, based on 3GPP specifications, allows reduction of current consumption and network utilization during periods of data inactivity.</p>
3GPP Power Saving Mode (PSM) ⁵	<p>The Power Saving Mode (PSM) feature, based on 3GPP specifications, allows further reduction of the module current consumption maximizing the amount of time a device can remain in PSM low power deep-sleep mode during periods of data inactivity.</p>
LTE eDRX	<p>Extended idle mode Discontinuous Reception (eDRX) feature, based on 3GPP specifications, reduces the amount of signaling overhead decreasing the frequency of scheduled measurements and/or transmissions performed by the module in idle mode. This in turn leads to a reduction in the module power consumption while maintaining a perpetual connection with the base station.</p>
Backup and restore	<p>This feature allows the modules to autonomously restore the flash file system using the last backup stored on the module itself. For further details about the backup and restore feature, see the +UBKUPDATA AT command description in the AT commands manual [1], and the related section in the application development guide [7]</p>

Table 4: Main features supported by LARA-L6 series modules

⁵ Not supported by LARA-L6004-00B and LARA-L6004D-00B product versions

2 Interfaces

2.1 Power management

2.1.1 Module supply input (VCC)

LARA-L6 series modules must be supplied through the three **VCC** pins by a DC power supply. Voltage must be stable, because during operation the current drawn from **VCC** can vary by some order of magnitude, especially due to the surging consumption profile of the GSM system (described in the system integration manual [2]). It is important that the external system power supply circuit can support peak power.

LARA-L6 series modules provide separate supply inputs over the three **VCC** pins:

- **VCC** pins #52 and #53 represent the supply input for the internal RF power amplifiers, demanding most of the total current drawn by the module when RF transmission is enabled
- **VCC** pin #51 represents the supply input for the internal baseband Power Management Unit and the internal transceiver, demanding a minor part of the total current drawn by the module when RF transmission is enabled

2.1.2 Generic digital interfaces supply output (V_INT)

LARA-L6 series modules provide a 1.8 V supply rail output on the **V_INT** pin, which is internally generated when the module is switched on. The same voltage domain is used internally to supply the generic digital interfaces of the modules (as the UARTs, I2C, I2S, GPIOs). The **V_INT** supply output can be used in place of an external discrete regulator.

 It is recommended to provide accessible test point directly connected to the **V_INT** input pin.

2.2 Antenna interfaces

2.2.1 Antenna RF interfaces

The modules have two RF pins with a characteristic impedance of 50 Ω . The primary antenna pin (**ANT1**) supports both Tx and Rx, providing the main antenna interface, while the secondary antenna pin (**ANT2**) supports Rx only for the LTE Down-Link MIMO 2x2 and 3G Rx diversity configuration.

2.2.2 Antenna detection

The **ANT_DET** pin is an Analog to Digital Converter (ADC) input with a current source provided by LARA-L6 series modules to sense the external antenna(s) presence (as an optional feature). It evaluates the resistance from **ANT1** and **ANT2** pins to GND by means of an external antenna detection circuit implemented on the application board. For more details, see the system integration manual [2] and the AT commands manual [1].

2.3 System functions

2.3.1 Module power-on

When LARA-L6 series modules are not powered, they can be switched on as following:

- Applying a voltage at the **VCC** module supply input within the operating range (see Table 11), and then forcing a low level at the **PWR_ON** input pin, which is normally set high by an internal pull-up, for a valid time period (see section 4.2.9, module switch on).

When LARA-L6 series modules are in power-off mode (switched off, with a voltage at the **VCC** module supply input within the normal operating range reported in [Table 11](#)), they can be switched on by:

- Forcing a low level at the **PWR_ON** input pin, which is normally set high by an internal pull-up, for a valid time period (see section [4.2.9](#), module switch on).

The **PWR_ON** line is intended to be driven by open drain, open collector, or contact switch.

 It is recommended to provide accessible test point directly connected to the **PWR_ON** input pin.

2.3.2 Module power-off

LARA-L6 series can be properly switched off, with storage of the current parameter settings in the module's internal non-volatile memory and a clean network detach, in one of these ways:

- AT+CPWROFF command (see the AT commands manual [\[1\]](#)).
- Forcing a low pulse at the **PWR_ON** input pin, which is normally set high by an internal pull-up, for a valid time period (see section [4.2.9](#), module graceful switch-off). The **PWR_ON** line is intended to be driven by open drain, open collector or contact switch.

An emergency faster and safe power-off procedure of LARA-L6 series modules, without proper network detach, can be triggered by:

- AT+CFUN=10 command (see the AT commands manual [\[1\]](#)).
- Toggling the GPIO input pin configured with the fast and safe power-off function (see section [2.8](#))

An abrupt shutdown occurs on LARA-L6 series modules, without storage of the current parameter settings and without a clean network detach, when:

- The **VCC** supply drops below the extended operating range minimum limit
- Forcing a low level at the **RESET_N** input pin, which is normally set high by an internal pull-up, for a valid time period (see [4.2.10](#), module abrupt emergency switch-off). The **RESET_N** line is intended to be driven by open drain, open collector or contact switch.

An over-temperature or an under-temperature shutdown occurs on LARA-L6 series modules when the temperature measured within the cellular module reaches the dangerous area, if the optional Smart Temperature Supervisor feature is enabled and configured by the dedicated AT command. For more details, see [4.2.15](#) and the AT commands manual [\[1\]](#), +USTS AT command.

2.3.3 Module reset

LARA-L6 series modules can be reset (rebooted), with storage of the current parameter settings in the module's internal non-volatile memory and a clean network detach, by:

- AT+CFUN=16 command (see the AT commands manual [\[1\]](#) for description and other options).
- Forcing a low level at the **RESET_N** input pin, which is normally set high by an internal pull-up, for a valid time period (see [4.2.10](#), module reset / reboot). The **RESET_N** line is intended to be driven by open drain, open collector or contact switch.

2.4 SIM interface

2.4.1 SIM card / chip interface

LARA-L6 series modules include an interface to connect an external SIM card / chip over the **VSIM**, **SIM_IO**, **SIM_CLK**, **SIM_RST** pins: the high-speed SIM/ME interface is implemented as well as the automatic detection of the required SIM supporting voltage.

Both 1.8 V and 3.0 V SIM types are supported (1.8 V and 3.0 V ME). Activation and deactivation with automatic voltage switch from 1.8 V to 3.0 V is implemented, according to ISO-IEC 7816-3 specs.

2.4.2 SIM card detection

LARA-L6 series modules provide the SIM detection function over the **GPIO5** pin to sense the SIM card physical presence (as an optional feature) when the pin of the module is properly connected to the mechanical switch of the SIM card holder (see the system integration manual [2]).

2.5 Serial communication

LARA-L6 series modules provide the following serial communication interfaces:

- Two UART interfaces: serial interfaces available for the communication with a host application processor (AT commands, data, FW update by FOAT).
- USB interface: Universal Serial Bus 2.0 compliant interface available for the communication with a host application processor (AT commands, data communication, FW update by the FOAT feature), for FW update by the u-blox EasyFlash tool and for diagnostic.
- I2C interface: I2C bus compatible interface available for the communication with u-blox GNSS positioning chips/modules and with external I2C devices as an audio codec.

2.5.1 UART interfaces

LARA-L6 series modules include a main primary Universal Asynchronous Receiver/Transmitter serial interface (UART) for communication with an application host processor, supporting AT commands, data communication, multiplexer protocol functionality including virtual channel for GNSS tunneling, and FW update by FOAT:

- 8-wire serial port with RS-232 functionality conforming to ITU-T V.24 recommendation [14], with CMOS compatible levels (0 V for low data bit / ON state, 1.8 V for high data bit / OFF state)
 - Data lines (**RXD** output, **TXD** input),
 - hardware flow control lines (**CTS** output, **RTS** input),
 - modem status and control lines (**DTR** input, **DSR** output, **DCD** output, **RI** output)⁶
- Hardware flow control (default factory-programmed setting), or none flow control are supported
- 115'200 bit/s (default factory-programmed setting), 230'400 bit/s, 460'800 bit/s, 921'600 bit/s, and 3'000'000 bit/s baud rates are supported
- The default factory-programmed frame format is 8N1 (8 data bits, no parity, 1 stop bit)

LARA-L6 series modules include a secondary auxiliary Universal Asynchronous Receiver/Transmitter serial interface (UART AUX) for communication with an application host processor, supporting AT commands, data communication, and FW update by FOAT:

- 4-wire serial port with RS-232 functionality conforming to ITU-T V.24 recommendation [14], with CMOS compatible signal levels (0 V for low data bit / ON state, 1.8 V for high data bit / OFF state)
 - Data lines (**DCD** as data output, **DTR** as data input)
 - HW flow control lines (**RI** as flow control output, **DSR** as flow control input)
- Hardware flow control (default setting), or none flow control are supported
- 115'200 bit/s (default setting), 230'400 bit/s, 460'800 bit/s, 921'600 bit/s, and 3'000'000 bit/s baud rates are supported
- The default frame format is 8N1 (8 data bits, no parity, 1 stop bit)

The UART serial interfaces can be conveniently configured through AT commands: for more details, see the AT commands manual [1] (+IPR, +ICF, +IFC, &K, \Q, &S, &D, &C, +UPSV, +USIO, +UUARTCONF AT commands).

⁶ Alternatively, **DTR**, **DSR**, **DCD** and **RI** pins can be mutually exclusively configured as a secondary auxiliary UART interface

2.5.1.1 Multiplexer protocol

LARA-L6 series modules include multiplexer functionality as per 3GPP TS 27.010 [10] on the main primary UART physical interface. The multiplexer functionality is not supported on the secondary auxiliary UART physical interface.

The multiplexer functionality is a data link protocol which uses HDLC-like framing and operates between the module (DCE) and the application processor (DTE), allowing several simultaneous sessions over the physical link (main primary UART): the user can concurrently use AT interface on one MUX channel and data communication on another MUX channel.

The following virtual channels are available (see the Mux implementation application note [5]):

- Multiplexer control
- AT commands / data connection
- GNSS data tunneling

2.5.2 USB interface

LARA-L6 series modules include a USB High-Speed 2.0 compliant interface with a maximum 480 Mbit/s data rate according to the Universal Serial Bus specification revision 2.0 [15]. The module itself acts as a USB device and can be connected to any compatible USB host.

The USB interface is available for communication with a host application processor (AT commands, data communication, GNSS tunneling, FW update the FOAT feature), for FW update the u-blox EasyFlash tool and for diagnostics.

The **USB_D+** / **USB_D-** lines carry the USB data and signaling. The USB interface is automatically enabled by an external valid USB VBUS voltage applied on the **VUSB_DET** input pin of the module.

 The USB interface of LARA-L6 series modules is enabled only if an external voltage detectable as High logic level (see Table 24 for the voltage values) is present at the **VUSB_DET** input during the module's switch-on boot sequence. This configuration can be changed by AT+UUSBDET command.

The USB interface provides several functions with various capabilities and purposes, such as:

- Virtual serial port over USB for AT commands and data communication
- Virtual serial port over USB for GNSS tunneling
- Virtual serial port over USB for Diagnostic log
- Ethernet over USB

The user can concurrently use the AT command interface on one CDC, and packet switched / circuit switched data communication on another CDC.

LARA-L6 series modules are compatible with the standard Linux/Android USB kernel drivers.

 It is highly recommended to provide access to the **VUSB_DET**, **USB_D+**, **USB_D-** pins for FW update and for diagnostic purpose, by test points directly connected to the pins.

2.5.3 I2C interface

LARA-L6 series modules include an I2C-bus compatible interface (**SDA** and **SCL** pins) available to communicate with an external u-blox GNSS chips / modules, and with external compatible I2C devices as for example an audio codec: LARA-L6 series module acts as an I2C host which can communicate with I2C local devices in accordance with the I2C bus specifications [16].

For more details regarding I2C interface usage and the integration with a u-blox GNSS receiver, see the system integration manual [2], GNSS implementation application note [4], and the I2C and GNSS AT commands description in the u-blox AT commands manual [1].

2.6 Audio interface

LARA-L6004D / LARA-L6804D data-only modules do not support voice / audio and the related 4-wire I2S digital audio interface (**I2S_TXD**, **I2S_RXD**, **I2S_CLK**, **I2S_WA**).

LARA-L6004 modules support Voice over LTE (VoLTE) as well as Circuit-Switched Fall-Back (CSFB) from LTE to 3G or 2G radio bearer for providing audio services. The modules include a 4-wire I2S digital audio interface (**I2S_TXD**, **I2S_RXD**, **I2S_CLK**, **I2S_WA**) that can be configured by AT command in PCM mode (short synchronization signal) or in normal I2S mode (long synchronization signal) to transfer digital audio data to/from an external device as an audio codec.

2.7 Clock output

LARA-L6004D / LARA-L6804D data-only modules do not support **GPIO6** clock output.

LARA-L6004 modules provide a digital clock output on **GPIO6** pin. This is mainly designed to feed the clock input of an external audio codec, as the clock output is generated only when the audio is active.

2.8 GPIO pins

LARA-L6 series modules include 9 pins (**GPIO1-GPIO5**, **I2S_TXD**, **I2S_RXD**, **I2S_CLK**, **I2S_WA**) that can be configured as General Purpose Input/Output or to provide custom functions as summarized in the [Table 5](#) (for further details, see the GPIO section in the AT commands manual [\[1\]](#)).

Function	Description	Default GPIO	Configurable GPIOs
Network status indication	Network status: registered home network, registered roaming, data transmission, no service	--	GPIO1, GPIO2, GPIO3, GPIO4
GNSS supply enable	Enable/disable the supply of u-blox GNSS receiver connected to the cellular module	GPIO2	GPIO1, GPIO2, GPIO3, GPIO4
GNSS data ready	Sense when u-blox GNSS receiver connected to the module is ready for sending data by the I2C	GPIO3	GPIO3
SIM card detection	External SIM card physical presence detection	GPIO5	GPIO5
SIM card hot insertion/removal	Enable / disable SIM interface upon detection of external SIM card physical insertion / removal	--	GPIO5
RI	Main UART Ring Indicator output function	--	All
DTR	Main UART DTR input line function	--	GPIO3, GPIO4
Last gasp	Input to trigger last gasp notification by applying a rising or falling edge according to AT+ULGASP setting	--	GPIO3
Faster and safe power-off	Input to trigger emergency fast and safe shutdown of the module (as AT+CFUN=10) by applying a rising edge	--	GPIO3
I2S digital audio interface ⁷	I2S digital audio interface	I2S_RXD, I2S_TXD, I2S_CLK, I2S_WA	I2S_RXD, I2S_TXD, I2S_CLK, I2S_WA
General purpose input	Input to sense high or low digital level	--	All
General purpose output	Output to set the high or the low digital level	GPIO4	All
Pin disabled	Tri-state with an internal active pull-down enabled	GPIO1	All

Table 5: GPIO custom functions configuration

⁷ I2S is not supported by LARA-L6004D / LARA-L6804D data-only modules: I2S pins are by default set as pin disabled.

2.9 Antenna dynamic tuner interface

 The antenna dynamic tuner interface is not supported by LARA-L6004-00B / LARA-L6004D-00B product versions.

LARA-L6 series modules include two 1.8 V digital output pins (**RFCTRL1** and **RFCTRL2**) that are configured to control in real time an external antenna tuning IC, as optional feature, changing their output value dynamically according to the actual cellular band in use by the module.

2.10 Reserved pins

LARA-L6 series modules include pins reserved for future use, marked as **RSVD**, which can all be left unconnected on the application board, except connecting a test point to the **RSVD #33** pin.

3 Pin definition

3.1 Pin assignment

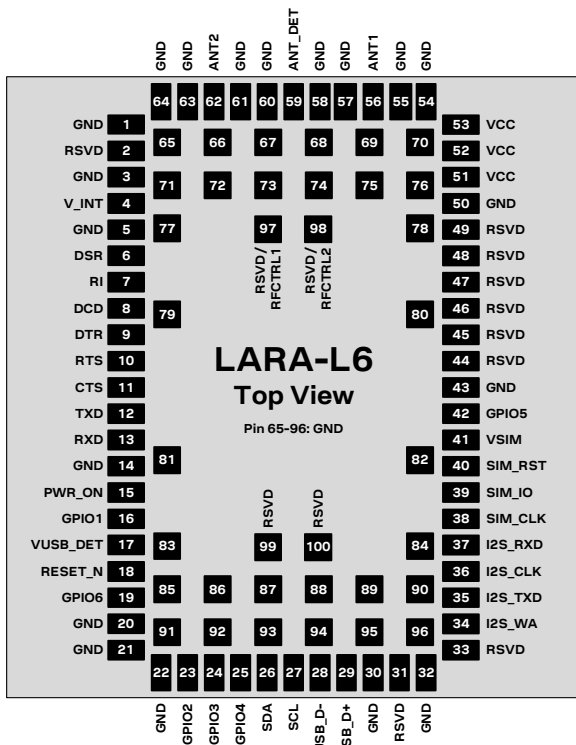

Figure 2: LARA-L6 series pin assignment (top view)

No	Name	Power domain	I/O	Description	Remarks
1	GND	-	N/A	Ground	All the GND pins are intended to be connected to ground
2	RSVD	-	N/A	RESERVED pin	Pin reserved for future use. Internally not connected.
3	GND	-	N/A	Ground	All the GND pins are intended to be connected to ground
4	V_INT	-	O	Generic Digital Interfaces supply output	V_INT = 1.8 V (typical) generated by the module when it is switched-on, outside low power deep sleep mode. See section 4.2.3 for detailed electrical specs. Provide test point for diagnostic purposes.
5	GND	-	N/A	Ground	All the GND pins are intended to be connected to ground
6	DSR	GDI	O/ I	UART data set ready / AUX UART request to send	Circuit 107 in ITU-T V.24 (DSR output, push-pull, idle high, active low), alternatively configurable as second auxiliary UART RTS (HW flow control input, idle high, active low, with internal active pull-up enabled). See section 4.2.14 for detailed electrical specs.
7	RI	GDI	O/ O	UART ring indicator / AUX UART clear to send	Circuit 125 in ITU-T V.24 (RI output, push-pull, idle high, active low), alternatively configurable as second auxiliary UART CTS (HW flow control output, push-pull, idle high, active low). See section 4.2.14 for detailed electrical specs.
8	DCD	GDI	O/ O	UART data carrier detect / AUX UART data output	Circuit 109 in ITU-T V.24 (DCD output, push-pull, idle high, active low), alternatively settable as Second Auxiliary UART RXD (data output, push-pull, idle high, active low). See section 4.2.14 for detailed electrical specs.

No	Name	Power domain	I/O	Description	Remarks
9	DTR	GDI	I/I	UART data terminal ready / AUX UART data input	Circuit 108/2 in ITU-T V. 24 (DTR input, idle high, active low, with internal active pull-up enabled), alternatively settable as Second Auxiliary UART TXD (data input, idle high, active low, with internal active pull-up enabled). See section 4.2.14 for detailed electrical specs.
10	RTS	GDI	I	UART ready to send	Circuit 105 in ITU-T V.24 (RTS flow control input, idle high, active low, with internal active pull-up enabled). See section 4.2.14 for detailed electrical specs.
11	CTS	GDI	O	UART clear to send	Circuit 106 in ITU-T V.24 (CTS hardware flow control output, push-pull, idle high, active low). See section 4.2.14 for detailed electrical specs.
12	TXD	GDI	I	UART data input	Circuit 103 in ITU-T V.24 (TxD data input, idle high, active low, with internal active pull-up enabled). See section 4.2.14 for detailed electrical specs.
13	RXD	GDI	O	UART data output	Circuit 104 in ITU-T V.24 (RxD data output, push-pull, idle high, active low). See section 4.2.14 for detailed electrical specs.
14	GND	-	N/A	Ground	All the GND pins are intended to be connected to ground
15	PWR_ON	POS	I	Power-on input	Internal pull-up. Active low. See section 4.2.9 for detailed electrical specs. Provide test point for diagnostic purposes.
16	GPIO1	GDI	I/O	GPIO	GPIO configurable as described in section 2.8. Push-pull output type. See section 4.2.14 for detailed electrical specs.
17	VUSB_DET	VBUS	I	VBUS USB detect input	VBUS (5 V typical) USB supply generated by the host must be connected to this input pin to enable the USB interface. See section 4.2.12 for detailed electrical specs. Provide test point for diagnostic purposes.
18	RESET_N	ERS	I	External reset input	Internal pull-up. Active low. See section 4.2.10 for detailed electrical specs.
19	GPIO6	GDI	O	Clock output	Configurable clock output as described in section 2.7. Push-pull output type. Not supported by LARA-L6001D / LARA-L6804D. See section 4.2.14 for detailed electrical specs.
20	GND	-	N/A	Ground	All the GND pins are intended to be connected to ground
21	GND	-	N/A	Ground	All the GND pins are intended to be connected to ground
22	GND	-	N/A	Ground	All the GND pins are intended to be connected to ground
23	GPIO2	GDI	I/O	GPIO	GPIO configurable as described in section 2.8. Push-pull output type. See section 4.2.14 for detailed electrical specs.
24	GPIO3	GDI	I/O	GPIO	GPIO configurable as described in section 2.8. Push-pull output type. See section 4.2.14 for detailed electrical specs.
25	GPIO4	GDI	I/O	GPIO	GPIO configurable as described in section 2.8. Push-pull output type. See section 4.2.14 for detailed electrical specs.
26	SDA	I2C	I/O	I2C bus data line	Open drain output type. Active low. Internal 2.2 kΩ pull-up resistor to V_INT. See section 4.2.13 for detailed electrical specs.
27	SCL	I2C	O	I2C bus clock line	Open drain output type. Active low. Internal 2.2 kΩ pull-up resistor to V_INT. See section 4.2.13 for detailed electrical specs.

No	Name	Power domain	I/O	Description	Remarks
28	USB_D-	USB	I/O	USB Data Line D-	90 Ω nominal differential characteristic impedance. Pull-up, pull-down and series resistors as required by the USB 2.0 specifications [15] are part of the USB pin driver, and need not be provided externally. See section 4.2.12 for detailed electrical specs. Provide test point for diagnostic purposes.
29	USB_D+	USB	I/O	USB Data Line D+	90 Ω nominal differential characteristic impedance. Pull-up, pull-down and series resistors as required by the USB 2.0 specifications [15] are part of the USB pin driver, and need not be provided externally. See section 4.2.12 for detailed electrical specs. Provide test point for diagnostic purposes.
30	GND	-	N/A	Ground	All the GND pins are intended to be connected to ground
31	RSVD	-	N/A	RESERVED pin	Pin reserved for future use. Internally not connected.
32	GND	-	N/A	Ground	All the GND pins are intended to be connected to ground
33	RSVD	-	N/A	RESERVED pin	Pin reserved with special function. Provide test point for diagnostic purposes.
34	I2S_WA	GDI	O / I/O	I2S word alignment / GPIO	Settable as GPIO (see section 2.8). Push-pull output type. I2S not supported by LARA-L6004D / LARA-L6804D. See section 4.2.14 for detailed electrical specs.
35	I2S_TXD	GDI	O / I/O	I2S transmit data / GPIO	Configurable as GPIO (see section 2.8). Push-pull output type. I2S not supported by LARA-L6004D / LARA-L6804D. See section 4.2.14 for detailed electrical specs.
36	I2S_CLK	GDI	O / I/O	I2S clock / GPIO	Configurable as GPIO (see section 2.8). Push-pull output type. I2S not supported by LARA-L6004D / LARA-L6804D. See section 4.2.14 for detailed electrical specs.
37	I2S_RXD	GDI	I / I/O	I2S receive data / GPIO	Configurable as GPIO (see section 2.8). Push-pull output type. I2S not supported by LARA-L6004D / LARA-L6804D. See section 4.2.14 for detailed electrical specs.
38	SIM_CLK	SIM	O	SIM clock	See section 4.2.10 for detailed electrical specs.
39	SIM_IO	SIM	I/O	SIM data	Internal 4.7 kΩ pull-up resistor to VSIM. See section 4.2.10 for detailed electrical specs.
40	SIM_RST	SIM	O	SIM reset	See section 4.2.10 for detailed electrical specs.
41	VSIM	-	O	SIM supply output	VSIM = 1.80 V typical or 2.95 V typical generated by the module according to the external SIM card/chip type. See section 4.2.3 for detailed electrical specs.
42	GPIO5	GDI	I/O	GPIO	Configurable for SIM card detection, or as GPIO (see 2.8). Push-pull output type. See section 4.2.14 for detailed electrical specs.
43	GND	-	N/A	Ground	All the GND pins are intended to be connected to ground
44	RSVD	-	N/A	RESERVED pin	Pin reserved for future use.
45	RSVD	-	N/A	RESERVED pin	Pin reserved for future use.
46	RSVD	-	N/A	RESERVED pin	Pin reserved for future use.
47	RSVD	-	N/A	RESERVED pin	Pin reserved for future use.
48	RSVD	-	N/A	RESERVED pin	Pin reserved for future use.
49	RSVD	-	N/A	RESERVED pin	Pin reserved for future use.
50	GND	-	N/A	Ground	All the GND pins are intended to be connected to ground

No	Name	Power domain	I/O	Description	Remarks
51	VCC	-	I	Module supply input	Supply input for baseband Power Management Unit part. All VCC pins must be connected to external supply. See sections 4.2.3 and 4.2.4 for detailed specs.
52	VCC	-	I	Module supply input	Supply for RF Power Amplifiers part. All VCC pins must be connected to external supply. See sections 4.2.3 and 4.2.4 for detailed specs.
53	VCC	-	I	Module supply input	Supply for RF Power Amplifiers part. All VCC pins must be connected to external supply. See sections 4.2.3 and 4.2.4 for detailed specs.
54	GND	-	N/A	Ground	All the GND pins are intended to be connected to ground
55	GND	-	N/A	Ground	All the GND pins are intended to be connected to ground
56	ANT1	ANT	I/O	Primary antenna	50 Ω nominal characteristic impedance. Main Tx/Rx antenna interface. See section 4.2.5, 4.2.6, 4.2.7 for details.
57	GND	GND	N/A	Ground	All the GND pins are intended to be connected to ground
58	GND	GND	N/A	Ground	All the GND pins are intended to be connected to ground
59	ANT_DET	ADC	I	Antenna detection	ADC input for antenna presence detection function. See section 4.2.8 for detailed electrical specs.
60	GND	GND	N/A	Ground	All the GND pins are intended to be connected to ground
61	GND	GND	N/A	Ground	All the GND pins are intended to be connected to ground
62	ANT2	ANT	I	Secondary antenna	50 Ω nominal characteristic impedance. Rx only for Down-Link LTE MIMO 2x2 and 3G Rx diversity. See section 4.2.5, 4.2.6 for details.
63	GND	-	N/A	Ground	All the GND pins are intended to be connected to ground
64	GND	-	N/A	Ground	All the GND pins are intended to be connected to ground
65-96	GND	-	N/A	Ground	All the GND pins are intended to be connected to ground
97	RFCTRL1	GDI	O	RF control output	Not supported by LARA-L6004-00B / LARA-L6004D-00B product versions. 1.8 V push-pull output to dynamically control external RF antenna tuning IC, changing the high/low state in real time according to the cellular RF band in use by the module. See section 4.2.14 for detailed electrical specs.
	RSVD		N/A	RESERVED pin	LARA-L6004-00B and LARA-L6004D-00B product versions only. Pin reserved for future use.
98	RFCTRL2	GDI	O	RF control output	Not supported by LARA-L6004-00B / LARA-L6004D-00B product versions. 1.8 V push-pull output to dynamically control external RF antenna tuning IC, changing the high/low state in real time according to the cellular RF band in use by the module. See section 4.2.14 for detailed electrical specs.
	RSVD	-	N/A	RESERVED pin	LARA-L6004-00B and LARA-L6004D-00B product versions only. Pin reserved for future use.
99	RSVD	-	N/A	RESERVED pin	Pin reserved for future use.
100	RSVD	-	N/A	RESERVED pin	Pin reserved for future use.



Table 6: LARA-L6 series pin-out

For more information about the pin-out, see the system integration manual [2].



See appendix A for an explanation of the abbreviations and terms used.

4 Electrical specifications

-  Stressing the device above one or more of the ratings listed in the Absolute Maximum Rating section may cause permanent damage. These are stress ratings only. Operating the module at these or at any conditions other than those specified in the Operating Conditions sections (section 4.2) of the specification should be avoided. Exposure to Absolute Maximum Rating conditions for extended periods may affect device reliability.
-  Electrical characteristics are defined according to the verification on a representative number of samples or according to the simulation.
-  Where application information is given, it is advisory only and does not form part of the specification.

4.1 Absolute maximum rating

-  Limit values given below are in accordance with the Absolute Maximum Rating System (IEC 134).

Symbol	Description	Condition	Min.	Max.	Unit
VCC	Module supply voltage	Input DC voltage at VCC pin	-0.5	6.0	V
VUSB_DET	USB detection pin	Input DC voltage at VUSB_DET pin	-0.3	5.5	V
USB	USB D+/D- pins	Input DC voltage at USB_D+ and USB_D- pins	-0.3	3.6	V
GDI	Generic digital interfaces	Input DC voltage at Generic digital interfaces pins	-0.3	2.1	V
I2C	I2C interface	Input DC voltage at I2C interface pins	-0.3	2.1	V
SIM	SIM interface	Input DC voltage at SIM interface pins	-0.3	3.6	V
ERS	External reset signal	Input DC voltage at RESET_N pin	-0.3	2.1	V
POS	Power-on input	Input DC voltage at PWR_ON pin	-0.3	2.1	V
Rho_ANT	Antenna ruggedness	Output RF load mismatch ruggedness at ANT pins		10:1	VSWR
Tstg	Storage Temperature		-40	+85	°C

Table 7: Absolute maximum ratings

-  The product is not protected against overvoltage or reversed voltages. If necessary, voltage spikes exceeding the power supply voltage specification, given in the table above, must be limited to values within the specified boundaries by using appropriate protection devices.

4.1.1 Maximum ESD

Parameter	Min.	Max.	Unit	Remarks
ESD sensitivity for all pins		1000	V	Human Body Model according to JS-001-2017
		500	V	Charged Device Model according to JS-002-2018

Table 8: Maximum ESD ratings

-  u-blox cellular modules are Electrostatic Sensitive Devices and require special precautions when handling. See section 7.4 for ESD handling instructions.

4.2 Operating conditions

Unless otherwise indicated, all operating condition specifications are at +25 °C temperature.

Operation beyond the operating conditions is not recommended and extended exposure beyond them may affect device reliability.

4.2.1 Operating temperature range

Parameter	Min.	Typical	Max.	Unit	Remarks
Normal operating temperature	-20	+25	+65	°C	Operating within 3GPP / ETSI specifications
Extended operating temperature	-40		+85	°C	Operating with possible slight deviation in RF performance outside normal operating range

Table 9: Environmental conditions

4.2.2 Thermal parameters

Symbol	Parameter	Min.	Typ.	Max.	Unit	Remarks
Ψ_{M-A}	Module-to-Ambient thermal parameter	10			°C/W	Thermal characterization parameter $\Psi_{M-A} = (T_M - T_A) / P_H$ proportional to the delta between internal module temperature (T_M) and ambient temperature (T_A), due to heat power dissipation (P_H), with the module mounted on a 79 x 62 x 1.41 mm 4-Layer PCB with a high coverage of copper, in still air conditions
Ψ_{M-C}	Module-to-Case thermal parameter	3			°C/W	Thermal characterization parameter $\Psi_{M-C} = (T_M - T_C) / P_H$ proportional to the delta between internal module temperature (T_M) and ambient temperature (T_C), due to heat power dissipation (P_H), with the module mounted on a 79 x 62 x 1.41 mm 4-Layer PCB with a high coverage of copper, with a robust aluminum heat-sink and with forced air ventilation, i.e. reducing to a value close to 0 °C/W the thermal resistance from the case of the module to the ambient

Table 10: Thermal characterization parameters of the module

4.2.3 Supply/power pins

Symbol	Parameter	Min.	Typical	Max.	Unit
VCC	Normal operating input voltage for VCC pins 51, 52, 53 ⁸	3.3	3.8	4.5	V
	Extended operating input voltage for VCC pin 51 ⁹	3.1	3.8	4.5	V
	Extended operating input voltage for VCC pins 52, 53 ¹⁰	2.8	3.8	4.5	V

Table 11: Input characteristics of the module Supply/Power pins

Symbol	Parameter	Min.	Typical	Max.	Unit
VSIM	SIM supply output voltage, with external 1.8 V SIM		1.80		V
	SIM supply output voltage, with external 3.0 V SIM		2.95		V
V_INT	Generic Digital Interfaces supply output voltage		1.80		V
	Generic Digital Interfaces supply output current capability			70	mA

Table 12: Output characteristics of the Supply/Power pins

⁸ Operating within 3GPP / ETSI specifications.

⁹ The voltage has to be above the extended operating range minimum limit for the **VCC** pin 51 (supply input for the baseband Power Management Unit and the Transceiver) to switch-on the module and to avoid possible switch-off of the module.

¹⁰ Operating with possible slight deviation in RF performance outside normal operating range. The power amplifier may not be fully functional when the voltage drops below the extended operating range minimum limit defined for the **VCC** pins 52 and 53 (supply input for the internal power amplifier).

4.2.4 Current consumption

Mode	Condition	Tx power	Min	Typ ¹¹	Max ¹²	Unit
Power-off mode	Averaged current value Module switched off			9		μA
Cyclic Idle/Active-Mode (Low power mode enabled by +UPSV, Module registered with network)	Averaged current value, Idle mode floor current, USB not connected			0.9		mA
	Averaged current value, Idle mode floor current, USB suspended			1.2		mA
	Averaged current value, Cyclic eDRX = 655.36 s, USB not connected			1.1		mA
	Averaged current value, Cyclic eDRX = 655.36 s, USB suspended			1.4		mA
	Averaged current value, Cyclic eDRX = 20.48 s, USB not connected			1.6		mA
	Averaged current value, Cyclic eDRX = 20.48 s, USB suspended			1.9		mA
	Averaged current value, Cyclic DRX = 2.56 s, USB not connected			1.9		mA
	Averaged current value, Cyclic DRX = 2.56 s, USB suspended			2.2		mA
Active-Mode (Low power mode disabled by +UPSV, Module registered with network)	Averaged current value, Cyclic DRX = 2.56 s, USB not connected			10.6		mA
	Averaged current value, Cyclic DRX = 2.56 s, USB in use			27.0		mA
2G Connected Mode (Tx / Rx call enabled)	Peak value at 1-slot GMSK Tx burst, 900 MHz band	Maximum		1.5	1.9	A
		Minimum		50		mA
	Averaged value along 1-slot GMSK call, 900 MHz band	Maximum		200		mA
		Minimum		50		mA
3G Connected Mode (Tx / Rx call enabled)	Averaged value along 3G call	Minimum		200		mA
		0 dBm		220		mA
		12 dBm		300		mA
		18 dBm		440		mA
		Maximum		620		mA
LTE Connected Mode (Tx / Rx call enabled)	Averaged value along LTE-FDD call, Low data rate	Minimum		250		mA
		0 dBm		270		mA
		12 dBm		320		mA
		18 dBm		450		mA
		Maximum		650		mA
	Averaged value along LTE-FDD call, High data rate	Maximum		690		mA

Table 13: LARA-L6 series modules VCC current consumption

¹¹ Typical values with a matched antenna

¹² Maximum values with a mismatched antenna

4.2.5 LTE RF characteristics

The LTE bands supported by each LARA-L6 module are defined in [Table 2](#), while [Table 14](#) describes the transmitting and receiving frequencies for each LTE band according to 3GPP TS 36.521-1 [11].

Parameter		Min.	Max.	Unit	Remarks
Frequency range FDD band 12 (700 MHz)	Uplink	699	716	MHz	Module transmits
	Downlink	729	746	MHz	Module receives
Frequency range FDD band 13 (700 MHz)	Uplink	777	787	MHz	Module transmits
	Downlink	746	756	MHz	Module receives
Frequency range FDD band 28 (700 MHz)	Uplink	703	748	MHz	Module transmits
	Downlink	758	803	MHz	Module receives
Frequency range FDD band 20 (800 MHz)	Uplink	832	862	MHz	Module transmits
	Downlink	791	821	MHz	Module receives
Frequency range FDD band 26 (850 MHz)	Uplink	814	849	MHz	Module transmits
	Downlink	859	894	MHz	Module receives
Frequency range FDD band 18 (850 MHz)	Uplink	815	830	MHz	Module transmits
	Downlink	860	875	MHz	Module receives
Frequency range FDD band 19 (850 MHz)	Uplink	830	845	MHz	Module transmits
	Downlink	875	890	MHz	Module receives
Frequency range FDD band 5 (850 MHz)	Uplink	824	849	MHz	Module transmits
	Downlink	869	894	MHz	Module receives
Frequency range FDD band 8 (900 MHz)	Uplink	880	915	MHz	Module transmits
	Downlink	925	960	MHz	Module receives
Frequency range FDD band 4 (1700 MHz)	Uplink	1710	1755	MHz	Module transmits
	Downlink	2110	2155	MHz	Module receives
Frequency range FDD band 3 (1800 MHz)	Uplink	1710	1785	MHz	Module transmits
	Downlink	1805	1880	MHz	Module receives
Frequency range FDD band 2 (1900 MHz)	Uplink	1850	1910	MHz	Module transmits
	Downlink	1930	1990	MHz	Module receives
Frequency range TDD band 39 (1900 MHz)	Uplink	1880	1920	MHz	Module transmits
	Downlink	1880	1920	MHz	Module receives
Frequency range FDD band 1 (2100 MHz)	Uplink	1920	1980	MHz	Module transmits
	Downlink	2110	2170	MHz	Module receives
Frequency range TDD band 40 (2300 MHz)	Uplink	2300	2400	MHz	Module transmits
	Downlink	2300	2400	MHz	Module receives
Frequency range TDD band 38 (2600 MHz)	Uplink	2570	2620	MHz	Module transmits
	Downlink	2570	2620	MHz	Module receives
Frequency range TDD band 41 (2600 MHz)	Uplink	2496	2690	MHz	Module transmits
	Downlink	2496	2690	MHz	Module receives
Frequency range FDD band 7 (2600 MHz)	Uplink	2500	2570	MHz	Module transmits
	Downlink	2620	2690	MHz	Module receives

Table 14: LTE operating RF frequency bands

LARA-L6 series modules include a UE Power Class 3 LTE transmitter (see [Table 2](#)), with output power and characteristics according to 3GPP TS 36.521-1 [11].

LARA-L6 series modules LTE receiver characteristics are compliant to 3GPP TS 36.521-1 [11], with LTE conducted receiver sensitivity performance described in [Table 15](#).

Parameter	Min.	Typical	Max.	Unit	Remarks
Receiver input sensitivity Band 12 (700 MHz)		-110		dBm	Channel bandwidth = 1.4 MHz
		-104		dBm	Channel bandwidth = 5 MHz
		-101		dBm	Channel bandwidth = 10 MHz
Receiver input sensitivity Band 13 (700 MHz)		-105		dBm	Channel bandwidth = 5 MHz
		-102		dBm	Channel bandwidth = 10 MHz
Receiver input sensitivity Band 28 (700 MHz)		-107		dBm	Channel bandwidth = 3 MHz
		-105		dBm	Channel bandwidth = 5 MHz
		-99		dBm	Channel bandwidth = 20 MHz
Receiver input sensitivity Band 20 (800 MHz)		-105		dBm	Channel bandwidth = 5 MHz
		-99		dBm	Channel bandwidth = 20 MHz
Receiver input sensitivity Band 26 (850 MHz)		-110		dBm	Channel bandwidth = 1.4 MHz
		-105		dBm	Channel bandwidth = 5 MHz
		-100		dBm	Channel bandwidth = 15 MHz
Receiver input sensitivity Band 18 (850 MHz)		-105		dBm	Channel bandwidth = 5 MHz
		-101		dBm	Channel bandwidth = 15 MHz
Receiver input sensitivity Band 19 (850 MHz)		-105		dBm	Channel bandwidth = 5 MHz
		-100		dBm	Channel bandwidth = 15 MHz
Receiver input sensitivity Band 5 (850 MHz)		-110		dBm	Channel bandwidth = 1.4 MHz
		-105		dBm	Channel bandwidth = 5 MHz
		-102		dBm	Channel bandwidth = 10 MHz
Receiver input sensitivity Band 8 (900 MHz)		-110		dBm	Channel bandwidth = 1.4 MHz
		-105		dBm	Channel bandwidth = 5 MHz
		-102		dBm	Channel bandwidth = 10 MHz
Receiver input sensitivity Band 4 (1700 MHz)		-110		dBm	Channel bandwidth = 1.4 MHz
		-104		dBm	Channel bandwidth = 5 MHz
		-99.		dBm	Channel bandwidth = 20 MHz
Receiver input sensitivity Band 3 (1800 MHz)		-107		dBm	Channel bandwidth = 1.4 MHz
		-102		dBm	Channel bandwidth = 5 MHz
		-97		dBm	Channel bandwidth = 20 MHz
Receiver input sensitivity Band 2 (1900 MHz)		-110		dBm	Channel bandwidth = 1.4 MHz
		-104		dBm	Channel bandwidth = 5 MHz
		-99		dBm	Channel bandwidth = 20 MHz
Receiver input sensitivity Band 1 (2100 MHz)		-104		dBm	Channel bandwidth = 5 MHz
		-99		dBm	Channel bandwidth = 20 MHz
Receiver input sensitivity Band 7 (2600 MHz)		-102		dBm	Channel bandwidth = 5 MHz
		-97		dBm	Channel bandwidth = 20 MHz
Receiver input sensitivity Band 39 (1900 MHz)		-105		dBm	Channel bandwidth = 5 MHz
		-100		dBm	Channel bandwidth = 20 MHz
Receiver input sensitivity Band 40 (2300 MHz)		-104		dBm	Channel bandwidth = 5 MHz
		-99		dBm	Channel bandwidth = 20 MHz
Receiver input sensitivity Band 38 (2600 MHz)		-103		dBm	Channel bandwidth = 5 MHz
		-98		dBm	Channel bandwidth = 20 MHz
Receiver input sensitivity Band 41 (2600 MHz)		-103		dBm	Channel bandwidth = 5 MHz
		-98		dBm	Channel bandwidth = 20 MHz

Condition: 50 Ω , throughput > 95%, dual receiver, QPSK modulation, other settings as per clause 7.3 of 3GPP TS 36.521-1 [11]

Table 15: LTE receiver sensitivity performance

4.2.6 3G RF characteristics

The 3G bands supported by LARA-L6 series modules are defined in [Table 2](#), while [Table 16](#) describes the transmitting and receiving frequencies for each 3G band according to 3GPP TS 34.121-1 [\[12\]](#).

Parameter		Min.	Max.	Unit	Remarks
Frequency range Band 5 (850 MHz)	Uplink	824	849	MHz	Module transmits
	Downlink	869	894	MHz	Module receives
Frequency range Band 8 (900 MHz)	Uplink	880	915	MHz	Module transmits
	Downlink	925	960	MHz	Module receives
Frequency range Band 2 (1900 MHz)	Uplink	1850	1910	MHz	Module transmits
	Downlink	1930	1990	MHz	Module receives
Frequency range Band 1 (2100 MHz)	Uplink	1920	1980	MHz	Module transmits
	Downlink	2110	2170	MHz	Module receives

Table 16: 3G operating RF frequency bands

LARA-L6 series modules include a UE Power Class 3 3G transmitter (see [Table 2](#)), with output power and characteristics according to 3GPP TS 34.121-1 [\[12\]](#).

LARA-L6 series modules 3G receiver characteristics are compliant to 3GPP TS 34.121-1 [\[12\]](#), with 3G conducted receiver sensitivity performance described in [Table 17](#).

Parameter	Min.	Typical	Max.	Unit	Remarks
Receiver input sensitivity Band 5 (850 MHz)		-115		dBm	Downlink RF level for RMC @ BER < 0.1%
Receiver input sensitivity Band 8 (900 MHz)		-115		dBm	Downlink RF level for RMC @ BER < 0.1%
Receiver input sensitivity Band 2 (2100 MHz)		-114		dBm	Downlink RF level for RMC @ BER < 0.1%
Receiver input sensitivity Band 1 (2100 MHz)		-114		dBm	Downlink RF level for RMC @ BER < 0.1%

Condition: 50 Ω , dual receiver, other settings as per clause 6.2 of 3GPP TS 34.121-1 [\[12\]](#)

Table 17: 3G receiver sensitivity performance

4.2.7 2G RF characteristics

The 2G bands supported by LARA-L6 series modules are defined in [Table 2](#), while [Table 18](#) describes the transmitting and receiving frequencies for each 2G band according to 3GPP TS 51.010-1 [\[13\]](#).

Parameter		Min	Max	Unit	Remarks
Frequency range GSM 850	Uplink	824	849	MHz	Module transmits
	Downlink	869	894	MHz	Module receives
Frequency range E-GSM 900	Uplink	880	915	MHz	Module transmits
	Downlink	925	960	MHz	Module receives
Frequency range DCS 1800	Uplink	1710	1785	MHz	Module transmits
	Downlink	1805	1880	MHz	Module receives
Frequency range PCS 1900	Uplink	1850	1910	MHz	Module transmits
	Downlink	1930	1990	MHz	Module receives

Table 18: 2G operating RF frequency bands

LARA-L6 series modules include a GMSK Power Class 4 transmitter for 850 / 900 MHz bands, GMSK Power Class 1 transmitter for 1800 / 1900 MHz bands, 8-PSK Power Class E2 transmitter for all 2G bands (see [Table 2](#)), with output power and characteristics according to 3GPP TS 51.010-1 [\[13\]](#).

LARA-L6 series modules 2G receiver characteristics are compliant to 3GPP TS 51.010-1 [13], with conducted receiver sensitivity performance described in Table 19.

Parameter	Min.	Typical	Max.	Unit	Remarks
Receiver input sensitivity E-GSM 850		-110		dBm	Downlink RF level @ BER Class II < 2.4%
Receiver input sensitivity E-GSM 900		-110		dBm	Downlink RF level @ BER Class II < 2.4%
Receiver input sensitivity E-GSM 1800		-109		dBm	Downlink RF level @ BER Class II < 2.4%
Receiver input sensitivity DCS 1900		-109		dBm	Downlink RF level @ BER Class II < 2.4%

Condition: 50 Ω, other settings as per clause 14.2.1 of 3GPP TS 51.010-1 [13]

Table 19: 2G receiver sensitivity performance

4.2.8 ANT_DET pin

Parameter	Min.	Typ.	Max.	Unit	Remarks
Output DC current pulse value		35		μA	Generated by the +UANTR AT command
Output DC current pulse time length		1160		μs	Generated by the +UANTR AT command

Table 20: ANT_DET pin characteristics

4.2.9 PWR_ON pin

Parameter	Min.	Typical	Max.	Unit	Remarks
Internal supply for PWR_ON Input Signal		1.8		V	The PWR_ON input is pulled up to an internal voltage rail minus a diode drop: the voltage value present at PWR_ON input pin is normally 0.8 V typical.
Low-level input	-0.30		0.35	V	
Pull-up resistance	150	200	250	kΩ	Internal active pull-up
Input leakage current	-0.20		0.20	μA	
PWR_ON low time	0.15		3.20	s	Low time to trigger module switch on from power off mode
	1.50			s	Low time to trigger module graceful switch off

Table 21: PWR_ON pin characteristics

4.2.10 RESET_N pin

Parameter	Min.	Typical	Max.	Unit	Remarks
Internal supply for RESET_N Input Signal		1.8		V	
Low-level input	-0.30		0.63	V	
Pull-up resistance		37		kΩ	Internal active pull-up
Input leakage current	-0.20		0.20	μA	
RESET_N low time	0.05		6	s	Low time to trigger module reset (reboot)
	10			s	Low time to trigger module abrupt emergency switch off

Table 22: RESET_N pin characteristics

4.2.11 SIM pins

The SIM pins are a dedicated interface to the external SIM card/chip. The electrical characteristics fulfill the regulatory specification requirements. The values in [Table 23](#) are for information only.

Parameter	Min.	Typ.	Max.	Unit	Remarks
Low-level input	-0.30		0.2*VSIM	V	
High-level input	0.7*VSIM		VSIM+0.3	V	
Low-level output		0	0.4	V	Max value at I _{OL} = +2.0 mA
High-level output	0.8*VSIM	VSIM		V	Max value at I _{OL} = +2.0 mA
Internal pull-up resistor on SIM_IO		4.7		kΩ	Internal pull-up to VSIM supply
Input leakage current	-2		2	μA	V _{IN} =0 V or V _{IN} =VSIM
Clock frequency on SIM_CLK		4.8		MHz	

Table 23: SIM pins characteristics

4.2.12 USB pins

USB data lines (**USB_D+** / **USB_D-**) are compliant with the USB 2.0 high-speed specification. See the Universal Serial Bus specification revision 2.0 [15] for detailed electrical characteristics. The values in [Table 24](#) related to USB 2.0 high-speed physical layer specifications are for information only.

Parameter	Min.	Typical	Max.	Unit	Remarks
VUSB_DET pin, High-level input	1.50	5.00	5.25	V	AT+UUSBDET=0 (default setting)
	4.40	5.00	5.25	V	AT+UUSBDET=1
High-speed squelch detection threshold (input differential signal amplitude)	100		150	mV	
High speed disconnect detection threshold (input differential signal amplitude)	525		625	mV	
High-speed data signaling input common mode voltage range	-50		500	mV	
High-speed idle output level	-10		10	mV	
High-speed data signaling output high level	360		440	mV	
High-speed data signaling output low level	-10		10	mV	
Chirp J level (output differential voltage)	700		1100	mV	
Chirp K level (output differential voltage)	-900		-500	mV	

Table 24: USB pins characteristics

4.2.13 I2C pins

I2C lines (**SCL** and **SDA**) are compliant with the I2C-bus standard mode specification. See the I2C-bus specification [16] for detailed electrical characteristics. The values in [Table 25](#) related to I2C-bus standard mode specifications are for information only.

Parameter	Min	Typical	Max	Unit	Remarks
Internal supply for GDI domain		1.80		V	Digital I/O Interfaces supply (V_INT)
Low-level input	-0.30	0.00	0.63	V	
High-level input	1.17	1.80	2.10	V	
Low-level output		0.00	0.45	V	Max value at I _{OL} = +2.0 mA
Internal pull-up resistance		2.2		kΩ	
Input/output leakage current	-1		1	μA	V _{IN} =0 V or V _{IN} =1.8V
Clock frequency on SCL		100		kHz	

Table 25: I2C pins characteristics

4.2.14 Generic Digital Interfaces pins

Parameter	Min	Typical	Max	Unit	Remarks
Internal supply for GDI domain		1.80		V	Digital I/O Interfaces supply (V_INT)
Low-level input	-0.30	0.00	0.63	V	
High-level input	1.17	1.80	2.10	V	
Low-level output		0.00	0.45	V	Max value at IOL = +2.0 mA
High-level output	1.35	1.80		V	Min value at IOH = -2.0 mA
Input leakage current	-1		1	μA	V _{IN} = 0 V or V _{IN} = 1.8V
Internal pull-up /-down resistance	55		390	kΩ	

Table 26: GDI pins characteristics

4.2.14.1 AC characteristics of clock output pin (GPIO6)

Parameter	Description	Min	Typical	Max	Unit	Remarks
1/T1	GPIO6 clock output frequency		12.288		MHz	AT+UMCLK=2

Table 27: AC characteristics of GPIO6 clock output pin

4.2.14.2 AC characteristics of I2S pins

Figure 3 and Table 28 show the AC characteristics in Normal I2S mode (long synchronization signal).

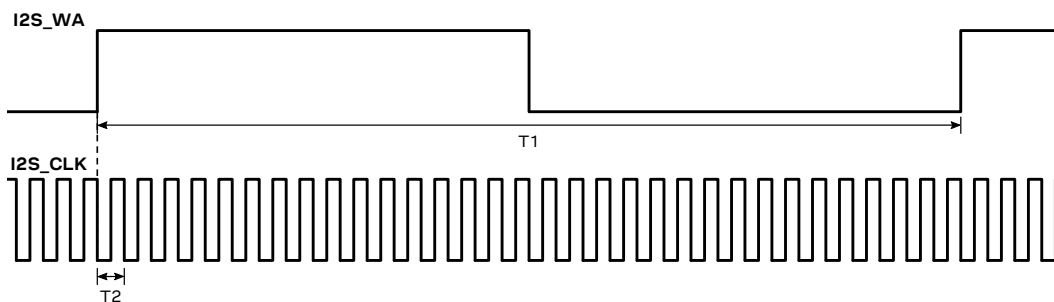

Figure 3: AC characteristics of I2S pins in Normal I2S mode, host role

Parameter	Description	Min	Typical	Max	Unit	Remarks
1/T1	I2S_WA synchronization signal frequency		16		kHz	<I2S_sample_rate> = 3
1/T2	I2S_CLK bit clock frequency		32		1/T1	<I2S_mode> = 14

Table 28: AC characteristics of I2S pins in Normal I2S mode, host role

Figure 4 and Table 29 show the AC characteristics in PCM I2S mode (short synchronization signal).

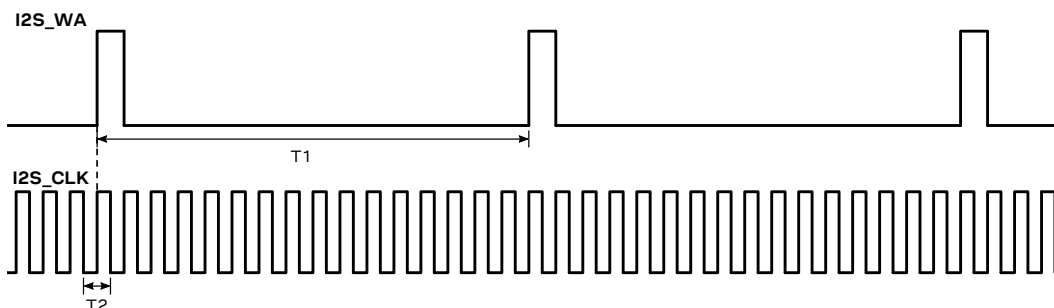

Figure 4: AC characteristics of I2S pins in PCM mode, host role

Parameter	Description	Min	Typical	Max	Unit	Remarks
1/T1	I2S_WA synchronization signal frequency		16		kHz	<I2S_sample_rate> = 3
1/T2	I2S_CLK bit clock frequency		16		1/T1	<I2S_mode> = 30

Table 29: AC characteristics of I2S pins in PCM mode, host role

4.2.15 Smart temperature supervisor

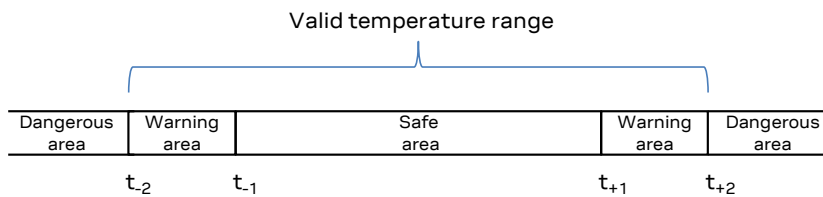

Figure 5: Temperature range and limits

Symbol	Parameter	Temperature
t_{-2}	Low temperature shutdown	-40 °C
t_{-1}	Low temperature warning	-30 °C
t_{+1}	High temperature warning	+77 °C
t_{+2}	High temperature shutdown	+97 °C

Table 30: Thresholds definition for the “Smart temperature supervisor” feature on the LARA-L6 series modules

The sensor measures the inside-shield temperature, which can differ from ambient temperature.

4.3 Parameters for ATEX applications

This section provides useful parameters and information to integrate LARA-L6 series modules in applications intended for use in areas with potentially explosive atmospheres (ATEX), describing:

- Total internal capacitance and inductance of LARA-L6 series modules (see [Table 31](#))
- Maximum RF output power at the antenna pin of LARA-L6 series modules (see [Table 32](#))

Any specific applicable requirement for the implementation of the host apparatus integrating the modules, intended for use in potentially explosive atmospheres, must be fulfilled according to the exact applicable standards: check the detailed requisites on the pertinent normative for the application, as for example IEC 60079-0 [\[17\]](#), IEC 60079-11 [\[18\]](#), IEC 60079-26 [\[19\]](#) standards.

The certification of the application device that integrates a LARA-L6 series module and the compliance of the application device with all the applicable certification schemes, directives and standards required for use in potentially explosive atmospheres are under the sole responsibility of the application device manufacturer.

[Table 31](#) describes the maximum total internal capacitance and the maximum total internal inductance, considering internal parts tolerance, provided by LARA-L6 series modules.

Module	Parameter	Description	Value	Unit
LARA-L6004, LARA-L6004D	Ci	Maximum total internal capacitance	496	μF
	Li	Maximum total internal inductance	9.8	μH
LARA-L6804D	Ci	Maximum total internal capacitance	496	μF
	Li	Maximum total internal inductance	9.7	μH

Table 31: LARA-L6 series maximum total internal capacitance and maximum total internal inductance

[Table 32](#) describes the maximum RF output power transmitted by LARA-L6 series modules from the primary antenna (**ANT1**) pin as Power Class 4 Mobile Stations for GSM 850 / E-GSM 900 bands and/or as Power Class 3 User Equipment for the LTE / UMTS bands.

Module	Parameter	Description	Value	Unit
LARA-L6004, LARA-L6004D	ANT1 Pout	Maximum RF output power from ANT1 pin	33.5	dBm
LARA-L6804D	ANT1 Pout	Maximum RF output power from ANT1 pin	33.5	dBm

Table 32: LARA-L6 series antenna pin (ANT1) maximum RF output power

5 Mechanical specifications

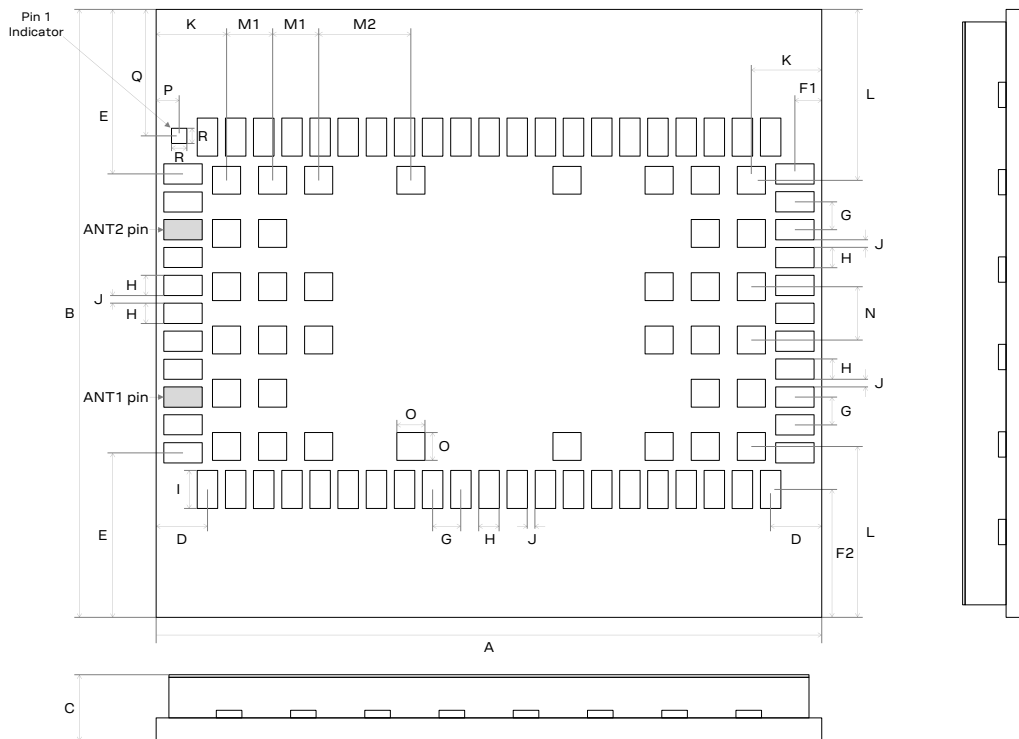

Figure 6: LARA-L6 series dimensions (bottom and side views)

Parameter	Description	Typical	Tolerance
A	Module height [mm]	26.0 (1023.6 mil)	+0.20/-0.20 (+7.9/-7.9 mil)
B	Module width [mm]	24.0 (944.9 mil)	+0.20/-0.20 (+7.9/-7.9 mil)
C	Module thickness [mm]	2.6 (102.4 mil)	+0.27/-0.17 (+10.6/-6.7 mil)
D	Horizontal edge to lateral pin pitch [mm]	2.0 (78.7 mil)	+0.20/-0.20 (+7.9/-7.9 mil)
E	Vertical edge to lateral pin pitch [mm]	6.5 (255.9 mil)	+0.20/-0.20 (+7.9/-7.9 mil)
F1	Edge to lateral pin pitch [mm]	1.05 (41.3 mil)	+0.20/-0.20 (+7.9/-7.9 mil)
F2	Edge to lateral pin pitch [mm]	5.05 (198.8 mil)	+0.20/-0.20 (+7.9/-7.9 mil)
G	Lateral pin to pin pitch [mm]	1.1 (43.3 mil)	+0.05/-0.05 (+2.0/-2.0 mil)
H	Lateral pin height [mm]	0.8 (31.5 mil)	+0.05/-0.05 (+2.0/-2.0 mil)
I	Lateral pin width [mm]	1.5 (59.1 mil)	+0.05/-0.05 (+2.0/-2.0 mil)
J	Lateral pin to pin distance [mm]	0.3 (11.8 mil)	+0.05/-0.05 (+2.0/-2.0 mil)
K	Horizontal edge to central pin pitch [mm]	2.75 (108.3 mil)	+0.20/-0.20 (+7.9/-7.9 mil)
L	Vertical edge to central pin pitch [mm]	6.75 (265.7 mil)	+0.20/-0.20 (+7.9/-7.9 mil)
M1	Central pin to pin horizontal pitch [mm]	1.8 (70.9 mil)	+0.05/-0.05 (+2.0/-2.0 mil)
M2	Central pin to pin horizontal pitch [mm]	3.6 (141.7 mil)	+0.05/-0.05 (+2.0/-2.0 mil)
N	Central pin to pin vertical pitch [mm]	2.1 (82.7 mil)	+0.05/-0.05 (+2.0/-2.0 mil)
O	Central pin height and width [mm]	1.1 (43.3 mil)	+0.05/-0.05 (+2.0/-2.0 mil)
P	Horizontal edge to pin 1 indicator pitch [mm]	0.9 (35.4 mil)	+0.20/-0.20 (+7.9/-7.9 mil)
Q	Vertical edge to pin 1 indicator pitch [mm]	5.0 (196.8 mil)	+0.20/-0.20 (+7.9/-7.9 mil)
R	Pin 1 indicator height and width [mm]	0.6 (23.6 mil)	+0.05/-0.05 (+2.0/-2.0 mil)
Weight	Module weight [g]	4	

Table 33: LARA-L6 series dimensions

Module width tolerance ± 0.20 mm may be exceeded close to the corners of the PCB due to the cutting process. In the worst case, the width could be $+0.40$ mm more than the typical value.

For information regarding footprint and paste mask recommended for the application board integrating the cellular module, see the system integration manual [2].

6 Qualification and approvals

6.1 Reliability tests

Reliability tests for LARA-L6 series modules are executed according to u-blox qualification policy, based on AEC-Q104 standard.

6.2 Approvals

LARA-L6 series modules comply with the Directive 2011/65/EU of the European Parliament and the Council on the Restriction of Use of certain Hazardous Substances in Electrical and Electronic Equipment (EU RoHS 2) and its amendment Directive (EU) 2015/863 (EU RoHS 3).

LARA-L6 series modules are RoHS 3 compliant.

No natural rubbers, hygroscopic materials, or materials containing asbestos are employed.

[Table 34](#) summarizes the main approvals achieved or planned for LARA-L6 series modules.

Certification scheme	LARA-L6004	LARA-L6004D	LARA-L6804D
CE (Europe)	●	●	■
UKCA (Great Britain)	●	●	■
FCC (United States)	●	●	
FCC ID	XPYUBX21BE01	XPYUBX21BE01	
ISED (Canada)	●	●	
ISED certification number	8595A-UBX21BE01	8595A-UBX21BE01	
ISED HVIN	LARA-L6004	LARA-L6004D	
NCC (Taiwan)	●	●	■
ACMA RCM (Australia)	●	●	■
GITEKI (Japan)	●	●	■
ANATEL (Brazil)		■	
GCF conformance		■	■
PTCRB conformance		■	
AT&T		■	
Verizon		■	
Deutsche Telekom		■	
Telefonica		■	
Telstra		■	
NTT DoCoMo			■
SoftBank Mobile			■
KDDI			■

● = "00B" and "01B" product versions ■ = "01B" product versions

Table 34: LARA-L6 series main certification approvals summary

 The above listed certifications might not be available for all the different product type numbers. Please contact the u-blox office or sales representative nearest you for the complete list of certification approvals available for the selected product ordering number.

7 Product handling & soldering

7.1 Packaging

LARA-L6 series modules are delivered as hermetically sealed reeled tapes, to enable efficient production, production lot set-up and tear-down.

For more information about packaging, see the u-blox package information user guide [6].

7.1.1 Reels

LARA-L6 series modules are deliverable in quantities of 150 pieces on a reel. The modules are delivered using the reel type B2 described in the u-blox package information user guide [6].

Quantities of less than 150 pieces are also available. Contact u-blox for more information.

7.1.2 Tapes

Figure 7 shows the position and the orientation of LARA-L6 series modules as they are delivered on the tape, while Figure 8 and Table 35 below specify the tape dimensions.

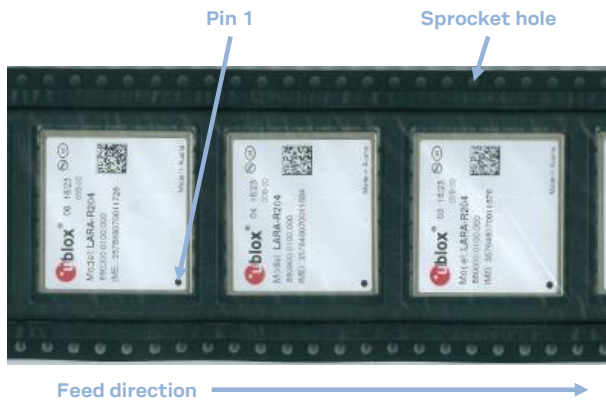

Figure 7: Orientation for LARA modules on tape

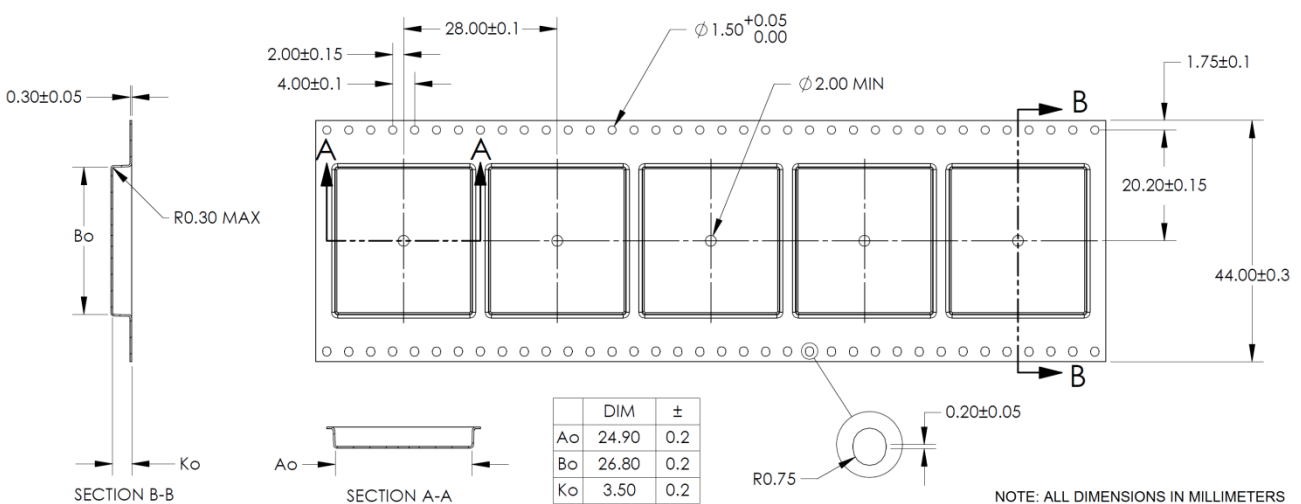





Figure 8: LARA-L6 series modules tape dimensions

Parameter	Typical value	Tolerance	Unit
A ₀	24.9	0.2	mm
B ₀	26.8	0.2	mm
K ₀	3.5	0.2	mm

Table 35: LARA-L6 series modules tape dimensions

-  10 sprocket hole pitch cumulative tolerance ± 0.2 mm.
-  Pocket position relative to sprocket hole measured as true position of pocket, not pocket hole.
-  A₀ and B₀ are measured on a plane at a distance “R” above the bottom of the pocket.

7.2 Moisture sensitivity levels

-  LARA-L6 series modules are Moisture Sensitive Devices (MSD) in accordance to the IPC/JEDEC specification.

The Moisture Sensitivity Level (MSL) relates to the packaging and handling precautions required. LARA-L6 series modules are rated at MSL level 4. For more information regarding moisture sensitivity levels, labeling, storage and drying see the u-blox package information user guide [6].

-  For the MSL standard, see IPC/JEDEC J-STD-020 (can be downloaded from www.jedec.org).

7.3 Reflow soldering

Reflow profiles are to be selected according to u-blox recommendations (see the system integration manual [2]).

-  Failure to observe these recommendations can result in severe damage to the device!

7.4 ESD precautions

-  LARA-L6 series modules contain highly sensitive electronic circuitry and are Electrostatic Sensitive Devices (ESD). Handling LARA-L6 series modules without proper ESD protection may destroy or damage them permanently.

LARA-L6 series modules are Electrostatic Sensitive Devices (ESD) and require special ESD precautions typically applied to ESD sensitive components.

[Table 8](#) details the maximum ESD ratings of the LARA-L6 series modules.

Proper ESD handling and packaging procedures must be applied throughout the processing, handling and operation of any application that incorporates the LARA-L6 series module.

ESD precautions should be implemented on the application board where the module is mounted, as described in the system integration manual [2].

-  Failure to observe these recommendations can result in severe damage to the device!

8 Labeling and ordering information

8.1 Product labeling

The label of LARA-L6 series modules include important product information as described in [Figure 9](#), as the label includes: u-blox logo, production lot, Pb-free marking, product type number, IMEI number, applicable regulatory certifications' info, and production country.

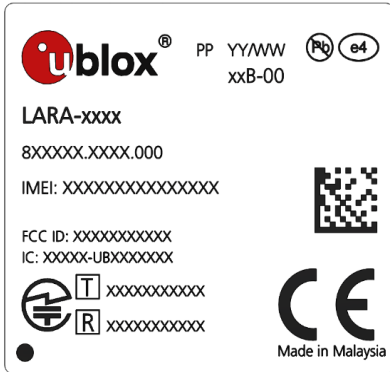

Figure 9: Illustrative example of LARA-L6 series modules' label

8.2 Explanation of codes

Three different product code formats are used. The Product Name is used in documentation such as this data sheet and identifies all the u-blox products, independent of packaging and quality grade. The Ordering Code includes options and quality, while the Type Number includes the hardware and firmware versions. [Table 36](#) details these 3 different formats:

Format	Structure
Product name	PPPP-TGVV(L)(HH)(F)
Ordering code	PPPP-TGVV(L)(HH)(F)-MMQ
Type number	PPPP-TGVV(L)(HH)(F)-MMQ-XX

Table 36: Product code formats

[Table 37](#) explains the parts of the product code.

Code	Meaning	Example
PPPP	Form factor	LARA
TG	Platform (technology and generation) <ul style="list-style-type: none"> Dominant technology: G: GSM; U: HSUPA; C: CDMA 1xRTT; N: NB-IoT (LTE Cat NB1/NB2); R: LTE low data rate (Cat 1 and Cat M1); L: LTE high data rate (Cat 3 and above) Generation: 1...9 	L6
VV	Variant function set based on the same platform: 00...99	00
(L)	LTE category (optionally indicated): 6,4,3,1,M ...	4
(HH)	GNSS generation (indicated if supported): M8 = u-blox M8, M9 = u-blox M9, ...	M8
(F)	Special features (optionally indicated): D = data only, ...	D
MM	Major product version: 00...99	00
Q	Product grade: B = professional, A = automotive	B
XX	Minor product version: 00...99	00

Table 37: Part identification code

8.3 Ordering information

Ordering number	Product
LARA-L6004-00B	Global LTE FDD / TDD Cat 4 module with 3G and 2G fallback. Voice and Data product version. 26.0 x 24.0 x 2.6 mm, 150 pcs/reel
LARA-L6004-01B	Global LTE FDD / TDD Cat 4 module with 3G and 2G fallback. Voice and Data product version. Maintenance release. 26.0 x 24.0 x 2.6 mm, 150 pcs/reel
LARA-L6004D-00B	Global LTE FDD / TDD Cat 4 module with 3G and 2G fallback. Data-only product version. 26.0 x 24.0 x 2.6 mm, 150 pcs/reel
LARA-L6004D-01B	Global LTE FDD / TDD Cat 4 module with 3G and 2G fallback. Data-only product version. Maintenance release. 26.0 x 24.0 x 2.6 mm, 150 pcs/reel
LARA-L6804D-01B	LTE FDD Cat 4 module with 3G and 2G fallback for multi-regional use. Data-only product version. 26.0 x 24.0 x 2.6 mm, 150 pcs/reel

Table 38: Product ordering codes

Appendix

A Glossary

Abbreviation	Definition
2G	2nd Generation Cellular Technology (GSM, GPRS, EGPRS)
3G	3rd Generation Cellular Technology (UMTS, HSDPA, HSUPA)
3GPP	3rd Generation Partnership Project
8-PSK	8 Phase-Shift Keying modulation
ACMA	Australian Communications and Media Authority
ADC	Analog to Digital Converter
ANATEL	Agência Nacional de Telecomunicações - National Telecommunications Agency (Brazil)
AT	AT Command Interpreter Software Subsystem, or attention
Cat	Category
CE	European Conformity
CSFB	Circuit Switched Fall-Back
DDC	Display Data Channel (I2C compatible) Interface
DL	Down-link (Reception)
DNS	Domain Name System
DTLS	Datagram Transport Layer Security
E2E	End-to-End
EAL5+	Evaluation Assurance Level 5+
eDRX	Extended Discontinuous Reception
ERS	External Reset Input Signal
ESD	Electrostatic Discharge
FCC	Federal Communications Commission (United States)
FDD	Frequency Division Duplexing
FOAT	Firmware update Over AT commands
FOTA	Firmware update Over The Air
FW	Firmware
GCF	Global Certification Forum
GDI	Generic Digital Interfaces (power domain)
GITEKI	Gijutsu kijun tekigō shōmei - technical standard conformity certification (Japan)
GMSK	Gaussian Minimum-Shift Keying modulation
GND	Ground
GNSS	Global Navigation Satellite System
GPIO	General Purpose Input Output
HSDPA	High Speed Downlink Packet Access
HSUPA	High Speed Uplink Packet Access
HVIN	Hardware Version Identification Number
I2C	Inter-Integrated Circuit Interface
I2S	Inter-IC Sound Interface
IEC	International Electrotechnical Commission
IMEI	International Mobile Equipment Identity
IMS	IP Multimedia Subsystem
ISED	Innovation, Science and Economic Development (Canada)

Abbreviation	Definition
KC	Korea Certification
KMS	Key Management Service
LGA	Land Grid Array
LPWA	Low Power Wide Area
LTE	Long Term Evolution
MIMO	Multiple-Input Multiple-Output
MNO	Mobile Network Operator
MUX	Multiplexer
NCC	National Communications Commission (Taiwan)
PA	Power Amplifier
PCB	Printed Circuit Board
PD	Pull-Down
PDP	Packet Data Protocol
POS	Power-On Input Signal
PMU	Power Management Unit
PSM	Power Saving Mode
PTCRB	PCS Type Certification Review Board
PU	Pull-Up
RAT	Radio Access Technology
RCM	Regulatory Compliance Mark
REST API	Representational State Transfer Application Programming Interface
RMC	Reference Measurement Channel
RTC	Real Time Clock
Rx	Receiver
TDD	Time Division Duplexing
TEE	Trusted Execution Environment
TLS	Transport Layer Security
Tx	Transmitter
UART	Universal Asynchronous Receiver/Transmitter serial interface
uFOTA	u-blox Firmware update Over The Air
UL	Up-link (Transmission)
UMTS	Universal Mobile Telecommunications System
VoLTE	Voice over LTE

Related documentation

- [1] u-blox LARA-R6 / LARA-L6 series AT commands manual, [UBX-21046719](#)
- [2] u-blox LARA-R6 / LARA-L6 series system integration manual, [UBX-21010011](#)
- [3] u-blox Android RIL source code application note, [UBX-13002041](#)
- [4] u-blox GNSS implementation application note, [UBX-13001849](#)
- [5] u-blox Mux implementation application note, [UBX-13001887](#)
- [6] u-blox package information user guide, [UBX-14001652](#)
- [7] u-blox LARA-R6 series application development guide, [UBX-22001850](#)
- [8] 3GPP TS 27.007 - AT command set for User Equipment (UE)
- [9] 3GPP TS 27.005 - Use of Data Terminal Equipment - Data Circuit terminating Equipment (DTE - DCE) interface for Short Message Service (SMS) and Cell Broadcast Service (CBS)
- [10] 3GPP TS 27.010 - Terminal Equipment to User Equipment (TE-UE) multiplexer protocol
- [11] 3GPP TS 36.521-1 - Evolved Universal Terrestrial Radio Access; User Equipment conformance specification; radio transmission and reception; part 1: conformance testing
- [12] 3GPP TS 34.121-1 - User Equipment conformance specification; radio transmission and reception (FDD); part 1: conformance specification
- [13] 3GPP TS 51.010-1 - Mobile Station conformance specification; part 1: conformance specification
- [14] ITU-T recommendation V24, 02-2000. List of definitions for interchange circuits between Data Terminal Equipment (DTE) and Data Connection Equipment (DCE)
- [15] Universal Serial Bus specification, revision 2.0, <https://www.usb.org/>
- [16] I2C-bus specification and user manual - UM10204, <https://www.nxp.com/>
- [17] IEC 60079-0 - Explosive atmospheres, part 0: equipment general requirements
- [18] IEC 60079-11 - Explosive atmospheres, part 11: equipment protection by intrinsic safety 'i'
- [19] IEC 60079-26 - Explosive atmospheres, part 26: equipment with EPL Ga

 For regular updates to u-blox documentation and to receive product change notifications, register on our homepage (www.u-blox.com).

Revision history

Revision	Date	Name	Comments
R01	22-Dec-2021	sses	Initial release
R02	20-Oct-2022	sses	Updated document applicability to LARA-L6004-00B and LARA-L6004D-00B product versions only. Revised supported features and compatible services. Added eDRX support. Updated HSDPA and HSUPA Category. Added reboot feature for RESET_N. Clarifications in USB description. Added smart temperature supervisor info. Added features for GPIOs. Added parameters for ATEX applications. Corrected position of a pad in mechanical description. Revised approvals. Added reels and tapes info. Minor editorial changes, other figures and clarifications added.
R03	28-Mar-2023	sses	Updated LARA-L6004-00B and LARA-L6004D-00B product status. Extended document applicability to LARA-L6004-01B, LARA-L6004D-01B and LARA-L6804D-01B. Revised HSUPA category and module dimension tolerance remark. Minor other editorial changes and clarifications added.

Contact

u-blox AG

Address: Zürcherstrasse 68
8800 Thalwil
Switzerland

For further support and contact information, visit us at www.u-blox.com/support.