

SAM-M8Q

Easy-to-use u-blox M8 GNSS antenna module

Data sheet



Abstract

Technical data sheet describing SAM-M8Q, a module which provides concurrent reception of up to three GNSS (GPS, Galileo, GLONASS). Its easy design-in requires no RF expertise and allows consistently strong performance regardless of installation. The surface-mount device with a tiny form factor (15.5 x 15.5 x 6.3 mm) enables simple and automated manufacturing.

Document information

Title	SAM-M8Q		
Subtitle	Easy-to-use u-blox M8 GNSS antenna module		
Document type	Data sheet		
Document number	UBX-16012619		
Revision and date	R06	16-Mar-2020	
Document status	Production Information		

Product status	Corresponding content status	
In Development / Prototype	Objective Specification	Target values. Revised and supplementary data will be published later.
Engineering Sample	Advance Information	Data based on early testing. Revised and supplementary data will be published later.
Initial Production	Early Production Information	Data from product verification. Revised and supplementary data may be published later.
Mass Production / End of Life	Production Information	Document contains the final product specification.

This document applies to the following products:

Product name	Type number	ROM/FLASH version	PCN reference
SAM-M8Q	SAM-M8Q-0-10	ROM SPG 3.01	N/A

u-blox or third parties may hold intellectual property rights in the products, names, logos and designs included in this document. Copying, reproduction, modification or disclosure to third parties of this document or any part thereof is only permitted with the express written permission of u-blox.

The information contained herein is provided "as is" and u-blox assumes no liability for its use. No warranty, either express or implied, is given, including but not limited to, with respect to the accuracy, correctness, reliability and fitness for a particular purpose of the information. This document may be revised by u-blox at any time without notice. For the most recent documents, visit www.u-blox.com.

Copyright © u-blox AG.

Contents

Document information	2
Contents	3
1 Functional description	5
1.1 Overview.....	5
1.2 Product features	6
1.3 Performance.....	6
1.4 Block diagram	7
1.5 Supported GNSS constellations	7
1.5.1 GPS	7
1.5.2 GLONASS	8
1.5.3 Galileo	8
1.6 Assisted GNSS (A-GNSS).....	8
1.6.1 AssistNow™ Online	8
1.6.2 AssistNow™ Offline.....	8
1.6.3 AssistNow™ Autonomous	9
1.7 Augmentation systems	9
1.7.1 Satellite-Based Augmentation System (SBAS)	9
1.7.2 QZSS	9
1.7.3 IMES	9
1.7.4 Differential GPS (D-GPS).....	10
1.8 Broadcast navigation data and satellite signal measurements	10
1.9 Odometer.....	10
1.10 Geofencing.....	10
1.11 Message Integrity Protection.....	10
1.12 Spoofing Detection	11
1.13 EXTINT: External interrupt.....	11
1.13.1 Pin control	11
1.13.2 Aiding	11
1.14 TIMEPULSE.....	11
1.15 Protocols and interfaces	12
1.16 Interfaces.....	12
1.16.1 UART	12
1.16.2 Display Data Channel (DDC)	12
1.17 Clock generation.....	12
1.17.1 Oscillators	12
1.17.2 Real-Time Clock (RTC).....	12
1.18 Power management	13
1.18.1 DC-DC converter	13
1.18.2 Power Mode Setup.....	13
1.18.3 Continuous Mode.....	13

1.18.4 Power Save Mode.....	13
1.19 Embedded antenna	14
1.19.1 Embedded antenna operation	14
1.19.2 Embedded antenna RF tuning.....	14
2 Pin definition	15
2.1 Pin assignment.....	15
3 Configuration management.....	16
4 Electrical specification	16
4.1 Absolute maximum rating.....	16
4.2 Operating conditions.....	16
4.3 Indicative current requirements	17
5 Mechanical specifications	18
6 Reliability tests and approvals.....	19
6.1 Reliability tests.....	19
6.2 Approvals.....	19
7 Product handling & soldering.....	20
7.1 Packaging	20
7.1.1 Reels	20
7.1.2 Tapes.....	20
7.2 Shipment, storage and handling	20
7.2.1 Moisture Sensitivity Levels	21
7.2.2 Reflow soldering.....	21
7.2.3 Antenna ageing.....	21
7.2.4 ESD handling precautions	21
8 Default messages	22
9 Labeling and ordering information	23
9.1 Product labeling.....	23
9.2 Explanation of codes	23
9.3 Ordering codes.....	23
Appendix	24
A Glossary	24
Related documents	25
Revision history	25
Contact.....	26

1 Functional description

1.1 Overview

The u-blox concurrent SAM-M8Q GNSS patch antenna module benefits from the exceptional performance of the u-blox M8 multi-GNSS engine. The SAM-M8Q module offers high sensitivity and minimal acquisition times in an ultra-compact form factor.

The SAM-M8Q module utilizes concurrent reception of up to three GNSS systems (GPS, Galileo and GLONASS), recognizes multiple constellations simultaneously and provides outstanding positioning accuracy in scenarios where urban canyon or weak signals are involved. For even better and faster positioning improvement, SAM-M8Q supports augmentation of QZSS, GAGAN and IMES together with WAAS, EGNOS, and MSAS. SAM-M8Q also supports message integrity protection, geofencing, and spoofing detection with configurable interface settings to easily fit to customer applications.

Incorporating the SAM-M8Q module into customer designs is simple and straightforward, thanks to the embedded GNSS patch antenna, low power consumption, a small footprint of 15.5 x 15.5 x 6.3 mm, simple interface, and sophisticated interference suppression that ensures maximum performance even in GNSS-hostile environments.

The 15 x 15 mm patch antenna provides the best compromise between the performance of a Right Hand Circular Polarized (RHCP) antenna and a small size to be integrated in any design. The omnidirectional radiation pattern increases flexibility for device installation. The simple SMD design and easy interfacing keeps design and manufacturing costs to a minimum. The SAM-M8Q features an additional front-end LNA for optimized performance and a front-end SAW filter for increased jamming immunity. The SAM-M8Q targets industrial and consumer applications that require small, cost efficient, and ready-to-use GNSS solutions.

The SAM-M8Q module uses AEC-Q100 qualified GNSS chips and is fully tested at the system level. Qualification is done according to the ISO 16750 standard.

The u-blox SAM-M8Q module can also benefit from the u-blox AssistNow assistance service. The Online service provides GNSS broadcast parameters, e.g. ephemeris, almanac plus time or rough position to reduce the receiver's time to first fix significantly and improve acquisition sensitivity. The extended validity of AssistNow Offline data (up to 35 days) and AssistNow Autonomous data (up to 3 days) provide faster acquisition after a long off time.

 See section [1.6](#) for more information concerning the SAM-M8Q related AssistNow Assistance.

1.2 Product features

Model	Category	GNSS				Supply	Interfaces	Features	Grade
	Standard Precision GNSS High Precision GNSS Dead Reckoning Timing	GPS / QZSS GLONASS Galileo BeiDou	Number of concurrent GNSS	2.7 V – 3.6 V	UART USB SPI DDC (I ² C compliant)	Programmable (flash) Data logging Additional SAW Additional LNA RTC crystal Oscillator Built-in antenna Built-in antenna supply and supervisor Timepulse	Standard Professional Automotive		
SAM-M8Q	•	• • •	3	•	• • •	• • • • T	1	•	

C = Crystal / T = TCXO

1.3 Performance

Parameter	Specification				
Receiver type	72-channel u-blox M8 engine GPS L1C/A, SBAS L1C/A, QZSS L1C/A, QZSS L1 SAIF, GLONASS L1OF, Galileo E1B/C				
Accuracy of time pulse signal	RMS	30 ns			
	99%	60 ns			
Frequency of time pulse signal	0.25 Hz...10 MHz (configurable)				
Operational limits ¹	Dynamics	≤ 4 g			
	Altitude	50,000 m			
	Velocity	500 m/s			
Velocity accuracy ²	0.05 m/s				
Heading accuracy ²	0.3 degrees				
GNSS	GPS & GLONASS	GPS	GLONASS	Galileo	
Horizontal position accuracy ³	2.5 m	2.5 m	8.0 m	TBC ⁴	
Max navigation update rate ⁵	10 Hz	18 Hz	18 Hz	18 Hz	
Time-To-First-Fix ⁶	Cold start	26 s	29 s	30 s	TBC 4
	Hot start	1 s	1 s	1 s	TBC 4
	Aided starts ⁷	2 s	2 s	3 s	TBC 4
Sensitivity ⁸	Tracking & Navigation	-165 dBm	-164 dBm	-164 dBm	-157 dBm
	Reacquisition	-158 dBm	-158 dBm	-154 dBm	-151 dBm
	Cold start	-146 dBm	-146 dBm	-143 dBm	-136 dBm
	Hot start	-155 dBm	-155 dBm	-154 dBm	-149 dBm

Table 1: SAM-M8Q (on 50 mm x 50 mm GND plane) performance in different GNSS modes (default: concurrent reception of GPS and GLONASS incl. QZSS, SBAS)

¹ Assuming Airborne < 4 g platform

² 50% @ 30 m/s

³ CEP, 50%, 24 hours static, good sky view

⁴ To be confirmed when Galileo reaches full operational capability

⁵ Rates with SBAS and QZSS enabled for > 98% fix report rate under typical conditions

⁶ Good sky view

⁷ Dependent on aiding data connection speed and latency

⁸ Demonstrated at the antenna feed point

1.4 Block diagram

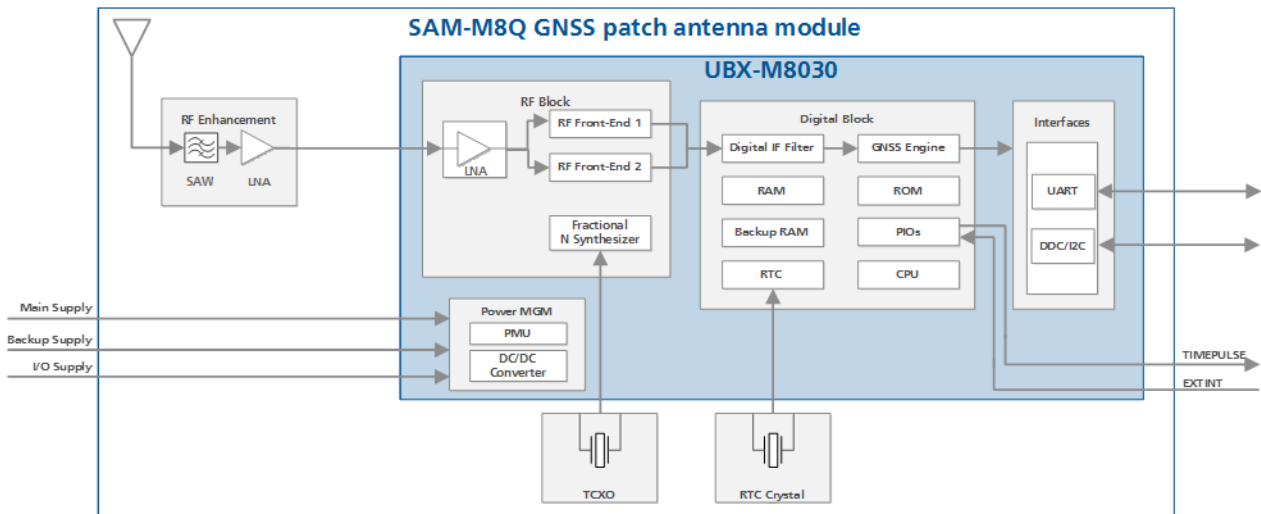

Figure 1: SAM-M8Q block diagram

1.5 Supported GNSS constellations

The SAM-M8Q GNSS module is a concurrent GNSS receiver which can receive and track multiple GNSS systems: GPS, Galileo and GLONASS. Owing to the dual-frequency RF front-end architecture, GLONASS can be processed concurrently with GPS and Galileo signals, thus providing reception of three GNSS systems. By default, the M8 receivers are configured for concurrent GPS and GLONASS, including SBAS and QZSS reception. If power consumption is a key factor, then the receiver should be configured for a single GNSS operation using GPS, Galileo or GLONASS and disabling QZSS and SBAS. The module can also be configured to receive any single GNSS constellation.

GPS	Galileo	GLONASS
•	•	–
•	•	•
•	–	•
•	–	–
–	•	•
–	•	–
–	–	•

Table 2: Permissible GNSS combinations (• = enabled)

- The augmentation systems: SBAS and QZSS can be enabled only if GPS operation is also configured.
- Galileo is not enabled as the default configuration.
- BeiDou reception is not supported by SAM-M8Q module.

1.5.1 GPS

The SAM-M8Q GNSS patch antenna module is designed to receive and track the L1C/A signals provided at 1575.42 MHz by the Global Positioning System (GPS).



1.5.2 GLONASS

The SAM-M8Q GNSS patch antenna module can receive and process the GLONASS satellite system as an alternative to the US-based Global Positioning System (GPS). The SAM-M8Q is designed to receive and track the L1OF signals which GLONASS provides at 1602 MHz + $k \cdot 562.5$ kHz, where k is the satellite's frequency channel number ($k = -7, \dots, 5, 6$). The ability to receive and track GLONASS L1OF satellite signals allows for the design of GLONASS receivers where required by regulations.

To take advantage of GPS and GLONASS, dedicated hardware preparation must be made during the design-in phase. See the SAM-M8Q Hardware Integration Manual [1] for u-blox design recommendations.

1.5.3 Galileo

The SAM-M8Q GNSS patch antenna module can receive and track the E1-B/C signals centered on the GPS L1 frequency band. GPS and Galileo signals can be processed concurrently together with GLONASS signals, enhancing coverage, reliability and accuracy. The SAR return link message (RLM) parameters for both short and long versions are decoded by the receiver and made available to users via UBX proprietary messages.

-  Galileo has been implemented according to ICD release 1.3 (December 2016). Since the Galileo satellite system has only recently reached Initial Services (IS) and not yet Full Operational Capability (FOC), changes to the Galileo signal specification (OS SIS ICD) remain theoretically possible. u-blox therefore recommends to use Flash memory in designs that utilize Galileo signals in order to allow for a firmware update in the unlikely event of a change to the Galileo signal specification (OS SIS ICD).
-  Galileo reception is disabled by default, but can be enabled by sending a configuration message (UBX-CFG-GNSS) to the receiver. See the u-blox 8 / u-blox M8 Receiver Description Including Protocol Specification [2] for more information.

1.6 Assisted GNSS (A-GNSS)

Supply of GNSS receiver assistance information, such as ephemeris, almanac, rough user position and time, will reduce the time to first fix significantly and improve acquisition sensitivity. All u-blox M8030 based products support the u-blox AssistNow Online and AssistNow Offline A-GNSS services, support AssistNow Autonomous, and are OMA SUPL compliant.

1.6.1 AssistNow™ Online

With AssistNow Online, an Internet connected host downloads assistance data from the u-blox AssistNow Online service to the receiver at system start-up. The Multi-GNSS Assistance (MGA) service is an HTTP protocol based network operator independent service.

Supplying assistance information, such as ephemeris, almanac, a rough last position and time, can reduce the time to first fix significantly and improve acquisition sensitivity.

-  The AssistNow Online service provides data for GPS, GLONASS, Galileo and QZSS

1.6.2 AssistNow™ Offline

With the AssistNow Offline service, users can download long-term orbit data over the Internet at their convenience. The orbit data can be stored within the memory of the application processor. The function requires no connectivity at system start-up, enabling a position fix within seconds, even when no network is available. AssistNow Offline offers augmentation for up to 35 days.

 AssistNow Offline service provides data for GPS and GLONASS only, Galileo is currently not supported

1.6.3 AssistNow™ Autonomous

AssistNow Autonomous provides aiding information without the need for a host or external network connection. Based on previous broadcast satellite ephemeris data downloaded to and stored by the GNSS receiver, AssistNow Autonomous automatically generates accurate predictions of satellite orbital data (“AssistNow Autonomous data”) that is usable for future GNSS position fixes. The concept capitalizes on the periodic nature of GNSS satellites; by capturing strategic ephemeris data at specific times of the day, the receiver can predict accurate satellite ephemeris for up to three days after initial reception.

The u-blox AssistNow Autonomous benefits are:

- Faster fix in situations where GPS satellite signals are weak
- No connectivity required
- Compatible with AssistNow Online (can work stand-alone, or in tandem with AssistNow Online service)
- No integration effort; calculations are done in the background, transparent to the user.

 The u-blox ROM-based SAM-M8Q receiver can use AssistNow Autonomous to calculate GPS only orbit predictions for 3 days.

 For more details on A-GNSS, see the u-blox 8 / u-blox M8 Receiver Description Including Protocol Specification [2].

1.7 Augmentation systems

1.7.1 Satellite-Based Augmentation System (SBAS)

The u-blox SAM-M8Q GNSS patch antenna module supports reception of SBAS broadcast signals. These systems supplement GNSS data with additional regional or wide area GPS augmentation data. The system broadcasts range correction and integrity information via satellite which can be used by GNSS receivers to improve the resulting precision. SBAS satellites can be used as additional satellites for ranging (navigation), further enhancing availability. The following SBAS types are supported: GAGAN, WAAS, EGNOS and MSAS.

 For more details, see the u-blox 8 / u-blox M8 Receiver Description Including Protocol Specification [2].

1.7.2 QZSS

The Quasi-Zenith Satellite System (QZSS) is a regional navigation satellite system that transmits additional GPS L1 C/A signals for the Pacific region covering Japan and Australia. SAM-M8Q GNSS patch antenna modules are able to receive and track these signals concurrently with GPS signals, resulting in better availability especially under challenging signal conditions, e.g. in urban canyons. The L1- SAIF signal provided by QZSS can be enabled for reception via a GNSS configuration message.

1.7.3 IMES

The Japanese Indoor MESSaging System (IMES) system is used for indoor position reporting using low-power transmitters which broadcast a GPS-like signal. SAM-M8Q GNSS patch antenna module can be configured to receive and demodulate the signal to provide an in-door location estimate.

 This service is authorized and available only in Japan.

 IMES reception is disabled by default.

1.7.4 Differential GPS (D-GPS)

u-blox receivers support Differential GPS (D-GPS) data according to RTCM specification 10402.3 [4]: The use of D-GPS improves GPS position accuracy. The RTCM implementation supports the following RTCM 2.3 messages.

Message Type	Description
1	Differential GPS Corrections
2	Delta Differential GPS Corrections
3	GPS Reference Station Parameters
9	GPS Partial Correction Set

Table 3: Supported RTCM 2.3 messages

 RTCM corrections cannot be used together with SBAS.

 For more details, see the u-blox 8 / u-blox M8 Receiver Description Including Protocol Specification [2].

1.8 Broadcast navigation data and satellite signal measurements

The SAM-M8Q GNSS patch antenna module can output all the GNSS broadcast data upon reception from tracked satellites. This includes all the supported GNSS signals plus the augmentation services SBAS, QZSS and IMES. The receiver also makes available the tracked satellite signal information, i.e. raw code phase and Doppler measurements in a form aligned to the Radio Resource LCS Protocol (RRLP) [6]. For more details, see the u-blox 8 / u-blox M8 Receiver Description Including Protocol Specification [2].

1.9 Odometer

The odometer function provides information on travelled ground distance (in meters) based on the position and Doppler-based velocity output from the navigation solution. For each computed distance since the last odometer reset, the odometer estimates a 1-sigma accuracy value. The total cumulative ground distance is maintained and saved in the BBR memory.

 The odometer feature is disabled by default. For more details, see the u-blox 8 / u-blox M8 Receiver Description Including Protocol Specification [2].

1.10 Geofencing

The u-blox SAM-M8Q GNSS patch antenna module supports up to four circular geofencing areas defined on the Earth's surface using a 2D model. Geofencing is active when at least one geofence is defined; the current status can be found by polling the receiver. A GPIO pin can be used to indicate status and, for instance, used to wake up a host on activation.

1.11 Message Integrity Protection

The SAM-M8Q GNSS patch antenna module provides a function to detect third party interference with the UBX message stream sent from receiver to host. The security mechanism “signs” nominated messages via a subsequent UBX message. This message signature is then compared with one generated by the host to determine if the message data has been altered. The signature algorithm

seed can use one fixed secret ID key set by eFuse in production and a dynamic ID key set by the host, enabling users to detect “man-in-the-middle” style attacks.

1.12 Spoofing Detection

Spoofing is a process whereby a malicious third party tries to control the reported position via a “fake” GNSS broadcast signal. This may result in the form of reporting incorrect position, velocity or time. To combat this, the SAM-M8Q GNSS patch antenna module includes spoofing detection measures to alert the host when signals appear to be suspicious. The receiver combines a number of checks on the received signals to look for inconsistencies across several parameters.

 This feature does not guarantee detection of all spoofing attacks.

1.13 EXTINT: External interrupt

EXTINT is an external interrupt pin with fixed input voltage thresholds with respect to **VCC_IO**. It can be used for control of the receiver or for aiding.

For more information about how to implement and configure these features, see the u-blox 8 / u-blox M8 Receiver Description Including Protocol Specification [2] and the SAM-M8Q Hardware Integration Manual [1].

1.13.1 Pin control

The pin control feature allows overriding the automatic active/inactive cycle of Power Save Mode. The state of the receiver can be controlled through the **EXTINT** pin.

The receiver can also be forced OFF using **EXTINT** when Power Save Mode is not active, see the u-blox 8 / u-blox M8 Receiver Description Including Protocol Specification [2].

1.13.2 Aiding

The **EXTINT** pin can be used to supply time or frequency aiding data to the receiver.

For time aiding, hardware time synchronization can be achieved by connecting an accurate time pulse to the **EXTINT** pin.

Frequency aiding can be implemented by connecting a periodic rectangular signal with a frequency up to 500 kHz and arbitrary duty cycle to the **EXTINT** pin. (The low/high phase duration of the cycle must not be shorter than 50 ns.) Provide the applied frequency value to the receiver using UBX messages.

1.14 TIMEPULSE

A configurable time pulse signal is available with all u-blox M8 modules.

The **TIMEPULSE** output generates pulse trains synchronized with GPS or UTC time grid with intervals configurable over a wide frequency range. Thus it may be used as a low frequency time synchronization pulse or as a high frequency reference signal.

By default, the time pulse signal is configured to 1 pulse per second. For more information, see the u-blox 8 / u-blox M8 Receiver Description Including Protocol Specification [2].

1.15 Protocols and interfaces

Protocol	Type
NMEA 0183, version 4.0 (V2.1, V2.3 or V4.1 configurable)	Input/output, ASCII
UBX	Input/output, binary, u-blox proprietary
RTCM	Input message, 1, 2, 3, 9

Table 4: Available Protocols

All protocols are available on UART and DDC (I²C compliant). For specification of the various protocols, see the u-blox 8 / u-blox M8 Receiver Description Including Protocol Specification [2].

1.16 Interfaces

A number of interfaces are provided either for data communication or memory access. The embedded firmware uses these interfaces according to their respective protocol specifications.

1.16.1 UART

The SAM-M8Q GNSS patch antenna module includes one UART interface, which can be used for communication to a host. It supports configurable baud rates. For supported baud rates, see the u-blox 8 / u-blox M8 Receiver Description Including Protocol Specification [2].

 Designs must allow access to the UART and the **SAFEBOOT_N** function pin for future service, updates and reconfiguration.

1.16.2 Display Data Channel (DDC)

An I²C compliant DDC interface is available for communication with an external host CPU or with u-blox cellular modules. The interface can be operated in slave mode only. The DDC protocol and electrical interface are fully compatible with Fast-Mode of the I²C industry standard. Since the maximum SCL clock frequency is 400 kHz, the maximum transfer rate is 400 kbit/s.

 The maximum bit rate is 400 kbit/s. The interface stretches the clock when slowed down when serving interrupts, so real bit rates may be slightly lower.

1.17 Clock generation

1.17.1 Oscillators

The SAM-M8Q GNSS patch module comes with TCXO. The TCXO allows accelerated weak signal acquisition, enabling faster start and reacquisition times.

TCXO used on the SAM-M8Q module is carefully selected and screened for stability and against frequency perturbations across the full operating range (−40 °C to +85 °C).

The careful selection and qualification of critical parts, such as GNSS TCXOs, has resulted in u-blox modules being the most reliable positioning modules in the industry, particularly in challenging conditions.

1.17.2 Real-Time Clock (RTC)

The RTC is driven by a 32 kHz oscillator using an RTC crystal. If the **VCC_IO** voltage fails, and a battery is connected to V_BCKP, parts of the receiver switch off, but the RTC still runs providing a timing reference for the receiver. This operating mode is called Hardware Backup Mode, which enables all relevant data to be saved in the backup RAM to allow a hot or warm start later.

1.18 Power management

u-blox M8 technology offers a power-optimized architecture with built-in autonomous power saving functions to minimize power consumption at any given time. Furthermore, the receiver can be used in two operating modes: Continuous mode for best performance or Power Save Mode for optimized power consumption.

1.18.1 DC-DC converter

The SAM-M8Q GNSS patch antenna module integrates a DC-DC converter, allowing reduced power consumption.

 For more information, see the SAM-M8Q Hardware Integration Manual [\[1\]](#).

1.18.2 Power Mode Setup

u-blox M8 modules can be configured to run in either continuous or a choice of Power Save mode configurations. A template of power mode settings can be used to easily select typical power mode setups to cover the majority of users' requirements.

For specific power saving applications, the user has the option to fully configure via the power save mode configuration.

The u-blox M8 modules' power mode setup offers a choice of continuous operation and preset Power Save Mode Configurations.

- Continuous (default) mode for best GNSS performance vs. power consumption
- Continuous with no compromise in power consumption
- A 1 Hz cyclic tracking mode for aggressive power reduction
- Choice of 2 or 4 Hz⁹ cyclic tracking modes for typical wearable applications
- ON/OFF interval mode

1.18.3 Continuous Mode

Continuous Mode uses the acquisition engine at full performance resulting in the shortest possible TTFF and the highest sensitivity. It searches for all possible satellites until the Almanac is completely downloaded. The receiver then switches to the tracking engine to lower power consumption.

Thus, a lower tracking current consumption level will be achieved when:

- A valid GNSS position is obtained
- The entire Almanac has been downloaded
- The Ephemeris for each satellite in view is valid

1.18.4 Power Save Mode

For specific power saving applications outside the typical preset power mode setups, users can configure a tailored Power Save Mode.

Power Save Mode provides two dedicated methods, ON/OFF and Cyclic tracking, that reduce average current consumption in different ways to match the needs of the specific application. These operations can be set by using a specific UBX message.

 For more information about power management strategies, see the u-blox 8 / u-blox M8 Receiver Description Including Protocol Specification [\[2\]](#).

⁹ Single GNSS constellation configuration only

1.19 Embedded antenna

The SAM-M8Q module has an embedded GNSS patch antenna and the signal is further filtered and amplified by internal SAW filter and internal Low Noise Amplifier (LNA).

-  Because the customer PCB is part of the antenna solution, some PCB layout design rules should be followed in order to maintain optimal performance of the on-board GNSS patch antenna. For more information, see the SAM-M8Q Hardware Integration Manual [\[1\]](#).

1.19.1 Embedded antenna operation

The embedded GNSS patch antenna provides an optimal radiation pattern with a 50x50 mm ground plane. The GNSS patch antenna is RHCP and has a peak gain of 3 dBiC. The patch antenna is insensitive to surroundings and has high tolerance against frequency shifts. However, on small ground plane widths, the antenna gain and radiation efficiency are reduced.

1.19.2 Embedded antenna RF tuning

To optimize the antenna performance, the operating frequency of the embedded GNSS patch antenna is tuned in the antenna production. The antenna tuning involves removing small parts of the antenna metalization, and the tuning marks can appear as scratches in the antenna element. This is not a fault in the product.

2 Pin definition

2.1 Pin assignment

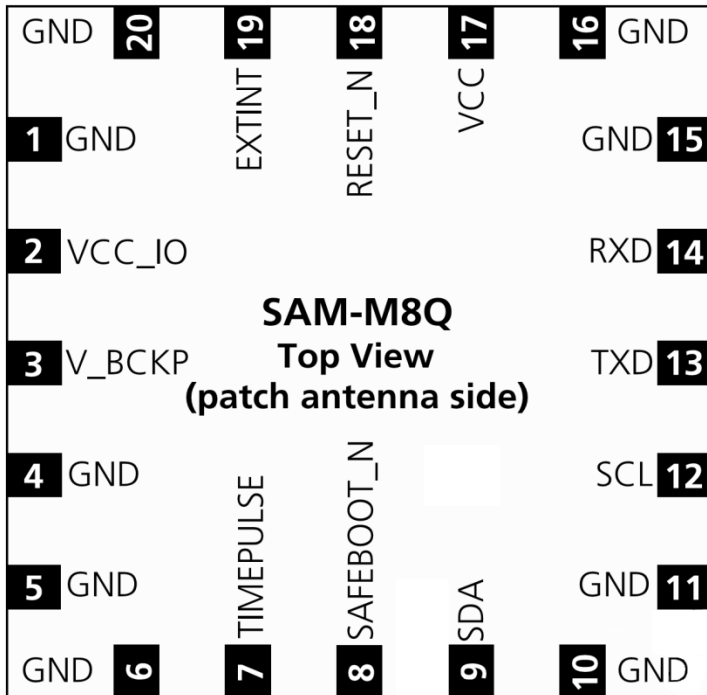

Figure 2: Pin assignment

No	Name	I/O	Description
1	GND		
2	VCC_IO	I	Supply for IO voltage
3	V_BCKP	I	Backup supply
4	GND		
5	GND		
6	GND		
7	TIMEPULSE	O	1 PPS
8	SAFEBOOT_N	I	Reserved
9	SDA	I/O	DDC data
10	GND		
11	GND		
12	SCL	I	DDC clock
13	TxD	O	UART Tx
14	RxD	I	UART Rx
15	GND		
16	GND		
17	VCC	I	Main Supply
18	RESET_N	I	Active Low
19	EXTINT0	I	External interrupt
20	GND		

Table 5: Pin-out of the SAM-M8Q

3 Configuration management

Configuration settings can be modified with UBX configuration messages. The modified settings remain effective until power-down or reset. If these settings have been stored in battery-backup RAM, then the modified configuration will be retained, as long as the backup battery supply is not interrupted.

4 Electrical specification

The limiting values given are in accordance with the Absolute Maximum Rating System (IEC 134). Stress above one or more of the limiting values may cause permanent damage to the device. These are stress ratings only, and operation of the device at these or at any other conditions above those given in the characteristics sections of the specification is not implied. Exposure to these limits for extended periods may affect device reliability.

Where application information is given, it is advisory only and does not form part of the specification. For more information, see the SAM-M8Q Hardware Integration Manual [1].

4.1 Absolute maximum rating

Parameter	Symbol	Condition	Min	Max	Units
Power supply voltage	VCC		-0.5	3.6	V
IO supply voltage	VCC_IO	VCC < 3.3V	-0.5	VCC + 0.3V	V
		VCC > 3.3V	-0.5	3.6	V
Backup battery voltage	V_BCKP		-0.5	3.6	V
Input pin voltage	V _{in}	If VCC_IO < 3.1V	-0.5	VCC_IO + 0.5	V
		If VCC_IO > 3.1V	-0.5	3.6	V
DC current through any digital I/O pin (except supplies)	I _{pin}			10	mA
Input power at RF_IN ¹⁰	P _{rf in}	source impedance = 50 Ω, continuous wave		0	dBm
Storage temperature	T _{stg}		-40	85	°C

Table 6: Absolute maximum ratings

Stressing the device beyond the “Absolute Maximum Ratings” may cause permanent damage. These are stress ratings only. The product is not protected against overvoltage or reversed voltages. If necessary, voltage spikes exceeding the power supply voltage specification, given in table above, must be limited to values within the specified boundaries by using appropriate protection diodes.

4.2 Operating conditions

All specifications are at an ambient temperature of +25 °C. Extreme operating temperatures can significantly impact specification values. Applications operating near the temperature limits should be tested to ensure the specification.

¹⁰ At the antenna feed point

Parameter	Symbol	Min	Typical	Max	Units	Condition
Power supply voltage	VCC	2.7	3.0	3.6	V	
IO supply voltage	VCC_IO	2.7	3.0	VCC + 0.3	V	VCC < 3.3V
		2.7	3.0	3.6	V	VCC > 3.3V
Backup battery voltage	V_BCKP	1.4		3.6	V	
Backup battery current	I_BCKP		15		μA	V_BCKP = 1.8 V, VCC = 0 V
SW backup current at VCC_IO	I_SWBCKP		20		μA	VCC_IO = 3 V
Input pin voltage range	V _{in}	0		VCC_IO + 0.5	V	
Digital IO Pin Low level input voltage	V _{il}	0		0.2*VCC_IO	V	
Digital IO Pin High level input voltage	V _{ih}	0.7*VCC_IO		VCC_IO + 0.5	V	
Digital IO Pin Low level output voltage	V _{ol}			0.4	V	I _{ol} = 4 mA
Digital IO Pin High level output voltage	V _{oh}	VCC_IO - 0.4			V	I _{oh} = 4 mA
Pull-up resistor at RESET_N (internal)	R _{pu}		11		kΩ	
Operating temperature	T _{opr}	-40		85	°C	

Table 7: Operating conditions

Operation beyond the specified operating conditions can affect device reliability.

4.3 Indicative current requirements

Table 8 lists examples of the total system supply current for a possible application.

Values in [Table 8](#) are only provided for customer information as an example of typical power requirements. Values are characterized on samples; actual power requirements can vary depending on the firmware version used, external circuitry, the number of SVs tracked, signal strength, type of start as well as time, duration and conditions of tests.

Parameter	Symbol	Typ GPS & GLONASS	Typ GPS	Max	Units	Condition
Max. supply current ¹¹	I _{ccp}			67	mA	
Average supply current ^{12, 13}	I _{cc} Acquisition ¹⁴	32	25		mA	Estimated at 3 V
	I _{cc} Tracking (Continuous mode)	29	23		mA	Estimated at 3 V
	I _{cc} Tracking (Power Save mode / 1 Hz)	9.5	9.5		mA	Estimated at 3 V

Table 8: Indicative power requirements at 3.0 V

For more information about power requirements, see the SAM-M8Q Hardware Integration Manual [\[1\]](#).

For more information on how to noticeably reduce current consumption, see the Power Management Application Note [\[5\]](#).

¹¹ Use this figure to dimension maximum current capability of power supply. Measure this parameter with 1 Hz bandwidth.

¹² Use this figure to determine required battery capacity.

¹³ Good sky view. VCC = 3.0 V

¹⁴ Average current from start-up until the first fix.

5 Mechanical specifications

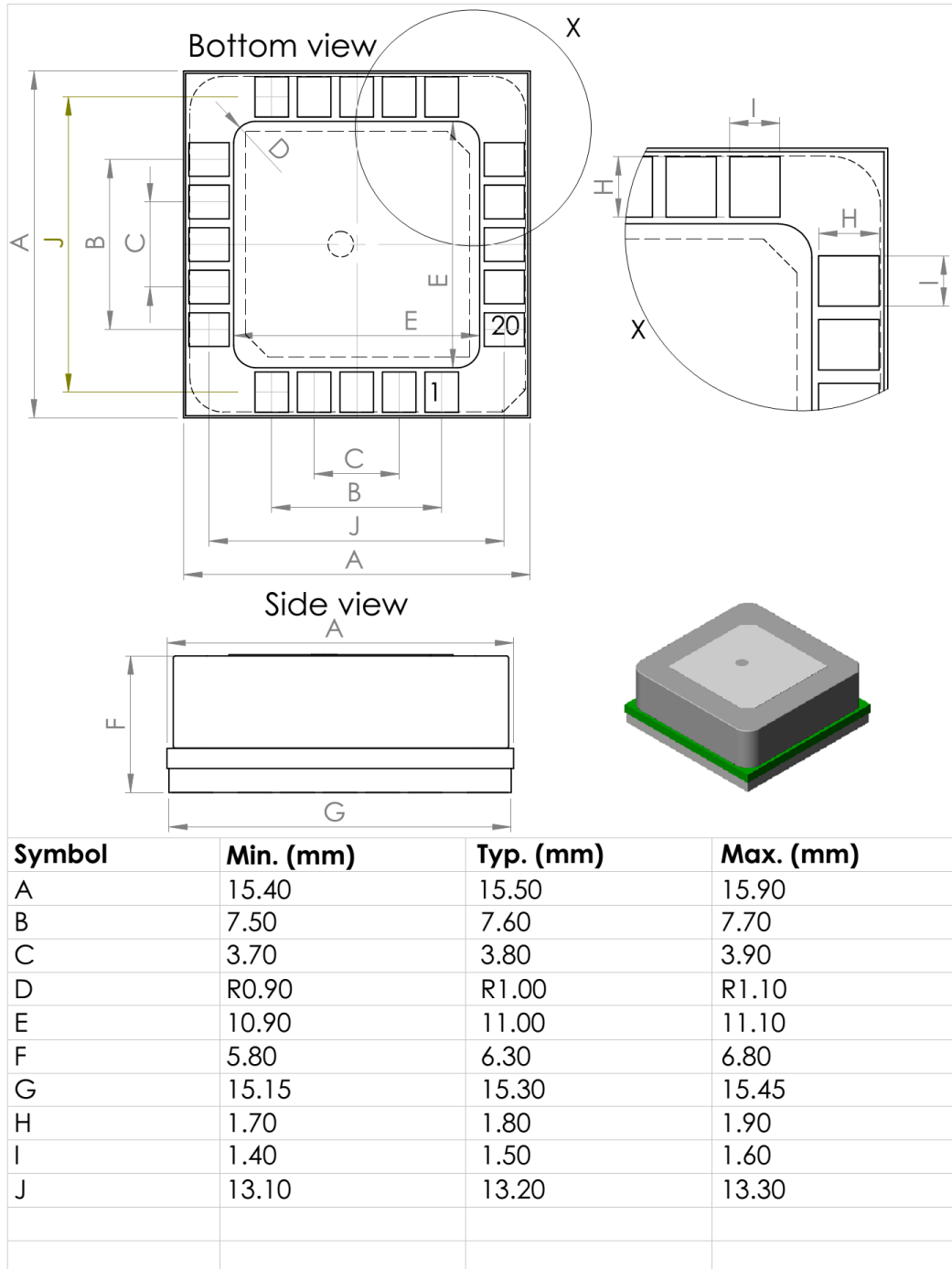



Figure 3: Dimensions

For information about the paste mask and footprint, see the SAM-M8Q Hardware Integration Manual [1].

6 Reliability tests and approvals

6.1 Reliability tests

 SAM-M8Q module is based on AEC-Q100 qualified GNSS chips.

Tests for product qualification are according to ISO 16750 "Road vehicles – environmental conditions and testing for electrical and electronic equipment", and appropriate standards

6.2 Approvals



The SAM-M8Q module complies with the Directives 2011/65/EU and 2015/863/EU of the European Parliament and the Council on the Restriction of Use of certain Hazardous Substances (RoHS).

7 Product handling & soldering

7.1 Packaging

SAM-M8Q module is delivered as hermetically sealed, reeled tapes in order to enable efficient production, production lot set-up and tear-down. For more information, see the u-blox Package Information Guide [3].

7.1.1 Reels

The SAM-M8Q GNSS patch antenna module is deliverable in quantities of 250 pieces on a reel. The SAM-M8Q modules are shipped on Reel Type A, as specified in the u-blox Package Information Guide [3].

7.1.2 Tapes

The dimensions and orientations of the tapes for SAM-M8Q modules are specified in Figure 4.

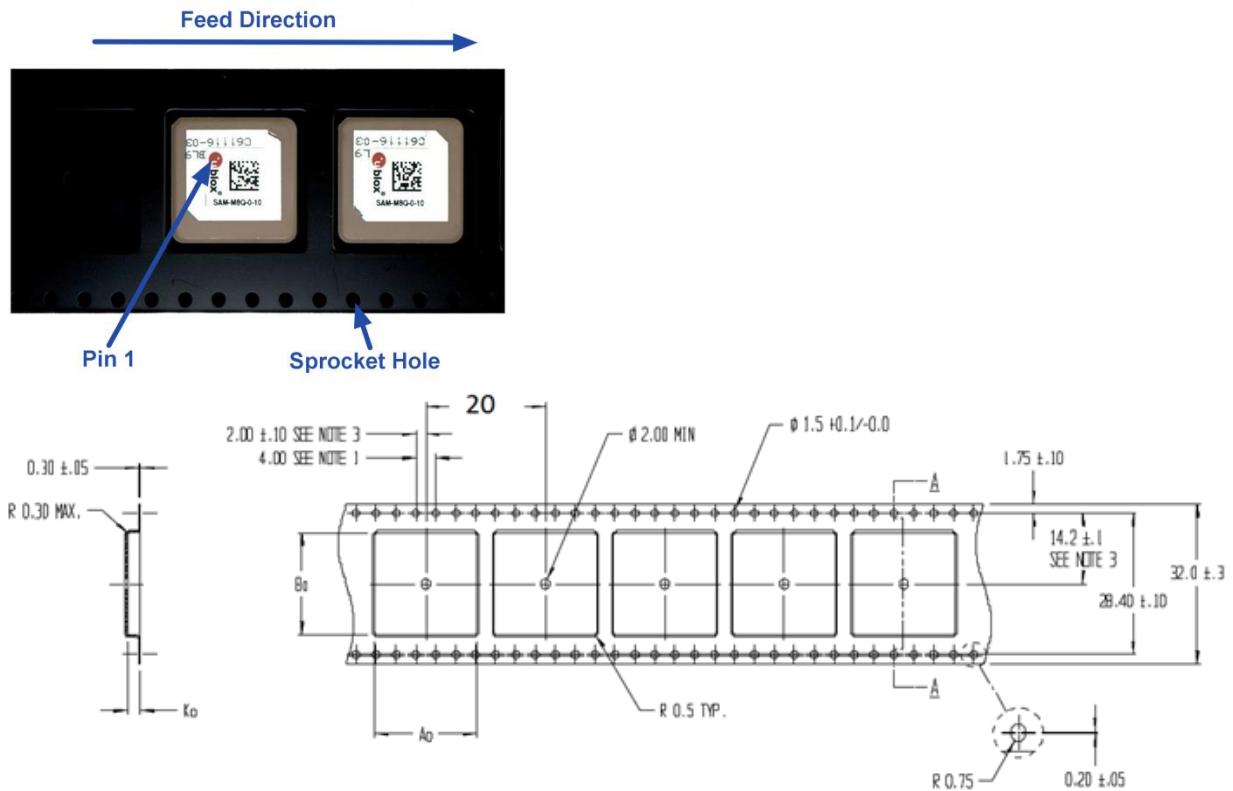

Parameter	Value	Units
Ao	16.2	mm
Bo	16.2	mm
Ko	7.0	mm

Figure 4: Dimensions and orientation for SAM-M8Q modules on tape

7.2 Shipment, storage and handling

For important information regarding shipment, storage and handling see the u-blox Package Information Guide [3]. The absolute maximum rating of the storage temperature specified in section 4.1 applies to the storage of the module both before and after soldering. Required storage

conditions for modules in reeled tapes and for naked modules before soldering are described in the u-blox Package Information Guide [3].

7.2.1 Moisture Sensitivity Levels

The Moisture Sensitivity Level (MSL) relates to the packaging and handling precautions required. The SAM-M8Q modules are rated at MSL level 4.

For MSL standard, see IPC/JEDEC J-STD-020, which can be downloaded from www.jedec.org.

For more information regarding MSL, see the u-blox Package Information Guide [3].

7.2.2 Reflow soldering

Reflow profiles are to be selected according u-blox recommendations (see the SAM-M8Q Hardware Integration Manual [1]).

7.2.3 Antenna ageing

Antenna electrode metallization is unprotected silver and will tarnish during storage due to sulfuric compounds present in the atmosphere. Elevated temperature and humidity will accelerate this process. Human skin contact, wool etc. will also cause tarnishing. This has no effect on the electrical performance of the antenna. u-blox accepts no warranty claims for tarnished products due to this normal and to be expected process.

7.2.4 ESD handling precautions

SAM-M8Q modules are Electrostatic Sensitive Devices (ESD). Observe precautions for handling! Failure to observe these precautions can result in severe damage to the GNSS receiver!

GNSS receivers are Electrostatic Sensitive Devices (ESD) and require special precautions when handling. Particular care must be exercised when handling patch antennas, due to the risk of electrostatic charges. In addition to standard ESD safety practices, the following measures should be taken into account whenever handling the receiver:

- Unless there is a galvanic coupling between the local GND (i.e. the work table) and the PCB GND, then the first point of contact when handling the PCB must always be between the local GND and PCB GND.
- Before mounting an antenna patch, connect the ground of the device.
- When handling the RF pin, do not come into contact with any charged capacitors and be careful when contacting materials that can develop charges (e.g. patch antenna ~10 pF, coax cable ~50-80 pF/m, soldering iron ...).
- To prevent electrostatic discharge through the RF input, do not touch any exposed antenna area. If there is any risk that such exposed antenna area is touched in non ESD protected work area, implement proper ESD protection measures in the design.
- When soldering RF connectors and patch antennas to the receiver's RF pin, make sure to use an ESD safe soldering iron (tip).

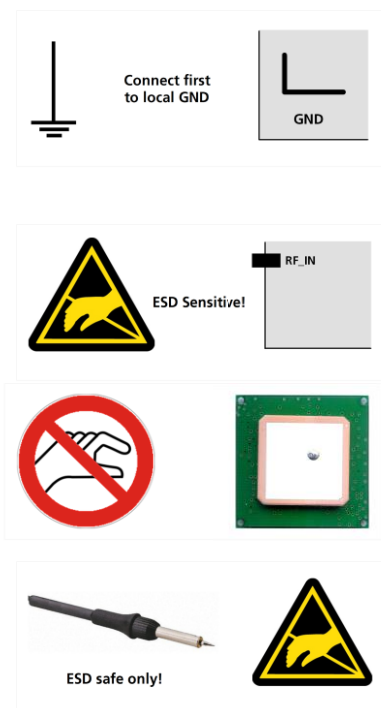

8 Default messages

Interface	Settings
UART Output	9600 Baud, 8 bits, no parity bit, 1 stop bit Configured to transmit both NMEA and UBX protocols, but only the following NMEA (and no UBX) messages have been activated at start-up: GGA, GLL, GSA, GSV, RMC, VTG, TXT
UART Input	9600 Baud, 8 bits, no parity bit, 1 stop bit, Autobauding disabled Automatically accepts following protocols without need of explicit configuration: UBX, NMEA, RTCM The GNSS receiver supports interleaved UBX and NMEA messages.
DDC	Fully compatible with the I ² C industry standard, available for communication with an external host CPU or u-blox cellular modules, operated in slave mode only. Default messages activated. NMEA and UBX are enabled as input messages, only NMEA as output messages. Maximum bit rate 400 kbit/s.
TIMEPULSE (1 Hz Nav)	1 pulse per second, synchronized at rising edge, pulse length 100 ms

Table 9: Default messages

 Refer to the u-blox 8 / u-blox M8 Receiver Description Including Protocol Specification [2] for information about other settings.

9 Labeling and ordering information

9.1 Product labeling

The labeling of the u-blox SAM-M8Q GNSS patch antenna module includes important product information. The location of the SAM-M8Q product type number is shown in Figure 5.

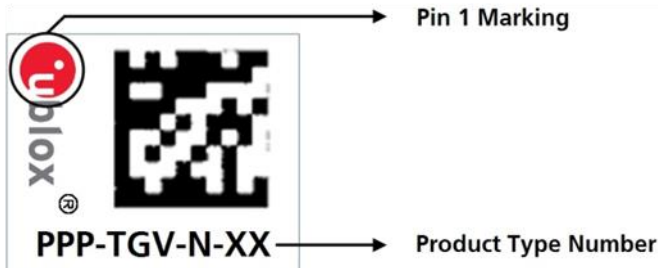

Figure 5: Location of product type number on u-blox SAM-M8Q module label

9.2 Explanation of codes

Three different product code formats are used. The **Product Name** is used in documentation such as this data sheet and identifies all u-blox M8 products, independent of packaging and quality grade. The **Ordering Code** includes options and quality, while the **Type Number** includes the hardware and firmware versions. Table 10 shows the structure of these three different formats.

Format	Structure
Product Name	PPP-TGV
Ordering Code	PPP-TGV-N
Type Number	PPP-TGV-N-XX

Table 10: Product code formats

The parts of the product code are explained in Table 11.

Code	Meaning	Example
PPP	Product Family	SAM
TG	Platform	M8 = u-blox M8
V	Variant	Function set (A-Z), T = Timing, R = DR, etc.
N	Option / Quality Grade	Describes standardized functional element or quality grade 0 = Default variant, A = Automotive
XX	Product Detail	Describes product details or options such as hard- and software revision, cable length, etc.

Table 11: Part identification code

9.3 Ordering codes

Ordering No.	Product
SAM-M8Q-0	u-blox M8 Concurrent GNSS LGA Patch antenna Module, TXCO, SAW, LNA, 15.5 x 15.5 x 6.3 mm, 250 pieces/reel

Table 12: Product ordering codes

Product changes affecting form, fit or function are documented by u-blox. For a list of Product Change Notifications (PCNs), see our website.

Appendix

A Glossary

Abbreviation	Definition
AEC	Automotive Electronics Council
BBR	Battery Backed RAM
DDC	Display Data Channel
EGNOS	European Geostationary Navigation Overlay Service
ESD	Electrostatic Sensitive Device
FOC	Full Operational Capability
GAGAN	GPS Aided GEO Augmented Navigation
GLONASS	GLObal Navigation Satellite System (Russian)
GND	Ground
GNSS	Global Navigation Satellite System
GPIO	General Purpose Input/Output
GPS	Global Positioning System
I2C	Inter-Integrated Circuit
IEC	International Electrotechnical Commission
IMES	Indoor MESSaging System
ISO	International Organization for Standardization
LCS	LoCation Services (protocol)
LGA	Land Grid Array
LNA	Low Noise Amplifier
MSAS	MTSAT Satellite Augmentation System
MSL	Moisture Sensitivity Level
NMEA	National Marine Electronics Association
PCB	Printed Circuit Board
PCN	Product Change Notification
PPS	Pulse Per Second
QZSS	Quasi-Zenith Satellite System
RLM	Return Link Message
RRLP	Radio Resource LCS Protocol
RTC	Real Time Clock
RTCM	Radio Technical Commission for Maritime Services
SAW	Surface Acoustic Wave
SBAS	Satellite-Based Augmentation System
SCL	Serial Clock
SMD	Solder Mask Defined
SUPL	Secure User Plane Location
TCXO	Temperature-Compensated Crystal Oscillator
TTF	Time-To-First-Fix
UART	Universal Asynchronous Receiver/Transmitter
UTC	Coordinated Universal Time
WAAS	Wide Area Augmentation System

Table 13: Explanation of the abbreviations and terms used

Related documents

- [1] SAM-M8Q Hardware Integration Manual, doc. no. UBX-16018358
- [2] u-blox 8 / u-blox M8 Receiver Description including Protocol Specification (public version), doc. no. UBX-13003221
- [3] u-blox Package Information Guide, doc. no. UBX-14001652
- [4] RTCM 10402.3 Recommended Standards for Differential GNSS, Ver. 2.3, RTCM AUG. 20, 2001
- [5] Power Management Application Note, doc. no. UBX-13005162
- [6] Radio Resource LCS Protocol (RRLP), (3GPP TS 44.031 version 11.0.0 Release 11)

 For regular updates to u-blox documentation and to receive product change notifications, register on our homepage (www.u-blox.com).

Revision history

Revision	Date	Name	Comments
R01	25-Nov-2016	mdur	Objective Specification
R02	13-Feb-2017	mdur	Advance Information, updated Table 1 (performance numbers), updated section 1.2, Table 6, Table 7 (power supply voltage range extended from 3.3 V to 3.6 V), updated section 4.3 (Indicative current requirements), added tape orientation to Figure 4.
R03	13-Mar-2017	mdur	Early Production Information
R04	24-Oct-2017	mdur	Production Information, product grade changed from Standard to Professional (updated section 1.1, section 1.2, and section 6.1), Absolute Maximum Rating for Vin modified in Table 6.
R05	27-Feb-2019	mdur	Added RoHS Directive 2015/863/EU in section 6.2, modified AssistNow™ Autonomous section 1.6.3, updated Table 6 and Table 7 (VCC_IO)
R06	16-Mar-2020	rmak	Added section 1.19.2. Embedded antenna RF tuning.

Contact

For complete contact information, visit us at www.u-blox.com.

u-blox Offices

North, Central and South America

u-blox America, Inc.

Phone: +1 703 483 3180
E-mail: info_us@u-blox.com

Regional Office West Coast:

Phone: +1 408 573 3640
E-mail: info_us@u-blox.com

Technical Support:

Phone: +1 703 483 3185
E-mail: support@u-blox.com

Headquarters

Europe, Middle East, Africa

u-blox AG

Phone: +41 44 722 74 44
E-mail: info@u-blox.com
Support: support@u-blox.com

Asia, Australia, Pacific

u-blox Singapore Pte. Ltd.

Phone: +65 6734 3811
E-mail: info_ap@u-blox.com
Support: support_ap@u-blox.com

Regional Office Australia:

Phone: +61 2 8448 2016
E-mail: info_au@u-blox.com
Support: support_ap@u-blox.com

Regional Office China (Beijing):

Phone: +86 10 68 133 545
E-mail: info_cn@u-blox.com
Support: support_cn@u-blox.com

Regional Office China (Chongqing):

Phone: +86 23 6815 1588
E-mail: info_cn@u-blox.com
Support: support_cn@u-blox.com

Regional Office China (Shanghai):

Phone: +86 21 6090 4832
E-mail: info_cn@u-blox.com
Support: support_cn@u-blox.com

Regional Office China (Shenzhen):

Phone: +86 755 8627 1083
E-mail: info_cn@u-blox.com
Support: support_cn@u-blox.com

Regional Office India:

Phone: +91 80 405 092 00
E-mail: info_in@u-blox.com
Support: support_in@u-blox.com

Regional Office Japan (Osaka):

Phone: +81 6 6941 3660
E-mail: info_jp@u-blox.com
Support: support_jp@u-blox.com

Regional Office Japan (Tokyo):

Phone: +81 3 5775 3850
E-mail: info_jp@u-blox.com
Support: support_jp@u-blox.com

Regional Office Korea:

Phone: +82 2 542 0861
E-mail: info_kr@u-blox.com
Support: support_kr@u-blox.com

Regional Office Taiwan:

Phone: +886 2 2657 1090
E-mail: info_tw@u-blox.com
Support: support_tw@u-blox.com