

ODIN-W2 series

Stand-alone multiradio modules with Wi-Fi and Bluetooth

Data sheet



Abstract

This technical data sheet describes the ODIN-W2 series short range multiradio modules with Wi-Fi and Bluetooth® dual-mode (Bluetooth BR/EDR and Bluetooth Low Energy v4.2). ODIN-W2 is a compact and powerful stand-alone multiradio module, designed for Internet-of-Things gateway applications. The Wi-Fi support conforms to IEEE 802.11a/b/g/n and has support for dual-band Wi-Fi (2.4 GHz and 5 GHz bands), 2x2 MIMO.

Document information

Title	ODIN-W2 series	
Subtitle	Stand-alone multiradio modules with Wi-Fi and Bluetooth	
Document type	Data sheet	
Document number	UBX-14039949	
Revision and date	R27	02-Jul-2025
Disclosure restriction	C1-Public	

Product status	Corresponding content status	
Functional sample	Draft	For functional testing. Revised and supplementary data will be published later.
In development / Prototype	Objective specification	Target values. Revised and supplementary data will be published later.
Engineering sample	Advance information	Data based on early testing. Revised and supplementary data will be published later.
Initial production	Early production information	Data from product verification. Revised and supplementary data may be published later.
Mass production / End of life	Production information	Document contains the final product specification.

This document applies to the following products:

Product name	Type number	Software version	Hardware version	PCN reference	Product status
ODIN-W260	ODIN-W260-05B-01	6.0.0, 6.0.1	07		End of Life
	ODIN-W260-06B-01	7.1.0	07		End of Life
	ODIN-W260-07B-00	8.4.0	07		Not recommended for new designs
ODIN-W262	ODIN-W262-05B-01	6.0.0, 6.0.1	07	UBXDOC-465451970-3158	End of Life
	ODIN-W262-06B-01	7.1.0	07	UBXDOC-465451970-3158	End of Life
	ODIN-W262-07B-00	8.4.0	07		Not recommended for new designs
ODIN-W263	ODIN-W263-06B-01	7.1.0	07		End of Life

u-blox or third parties may hold intellectual property rights in the products, names, logos, and designs included in this document. Copying, reproduction, or modification of this document or any part thereof is only permitted with the express written permission of u-blox. Disclosure to third parties is permitted for clearly public documents only.

The information contained herein is provided "as is" and u-blox assumes no liability for its use. No warranty, either express or implied, is given, including but not limited to, with respect to the accuracy, correctness, reliability, and fitness for a particular purpose of the information. This document may be revised by u-blox at any time without notice. For the most recent documents, visit www.u-blox.com.

Copyright © u-blox AG.

Contents

Document information	2
Contents	3
1 Functional description	6
1.1 Overview.....	6
1.2 Applications	6
1.3 Product features	7
1.4 Block diagram	8
1.5 Product description	9
1.6 AT command support	9
1.7 IEEE 802.11d and additional regulatory domains.....	10
1.7.1 ODIN-W2 IEEE 802.11d implementation description.....	10
1.8 MAC addresses	12
2 Interfaces	13
2.1 Power management	13
2.1.1 Module supply input (VCC)	13
2.1.2 Digital I/O interfaces supply output (V_INT)	13
2.2 Antenna interfaces.....	13
2.2.1 Antenna connectors and internal antenna	13
2.3 Data communication interfaces	14
2.3.1 UART interface.....	14
2.3.2 Ethernet interface	14
3 System functions	16
3.1 Module power modes	16
3.2 Module reset	16
3.3 IO signals.....	16
3.3.1 System status IO signals	16
3.3.2 System control IO signals	16
3.3.3 UART IO signals.....	17
4 Pin definition	18
4.1 Pin assignment.....	18
5 Electrical specification	22
5.1 Absolute maximum ratings	22
5.1.1 Maximum ESD.....	22
5.2 Operating conditions.....	22
5.2.1 Temperature range	22
5.2.2 Power supply.....	23
5.2.3 I/O DC characteristics	23
5.2.4 Reset characteristics.....	23
5.2.5 LPO clock	24
5.2.6 Universal asynchronous serial interface (UART)	24

5.3	Power consumption	24
5.3.1	General power consumption	24
5.3.2	Wi-Fi 2.4 GHz power consumption	25
5.3.3	Wi-Fi 5 GHz power consumption	25
5.3.4	Classic Bluetooth power consumption	25
5.3.5	Bluetooth Low Energy (LE) power consumption	26
5.4	RF characteristics	26
5.4.1	Wi-Fi radio characteristics	26
5.4.2	Wi-Fi receiver characteristics 2.4 GHz	26
5.4.3	Wi-Fi receiver characteristics 5 GHz	27
5.4.4	Wi-Fi transmitter characteristics 2.4 GHz	27
5.4.5	Wi-Fi transmitter characteristics 5 GHz	28
5.4.6	Classic Bluetooth receiver characteristics	28
5.4.7	Bluetooth Low Energy receiver sensitivity	28
5.4.8	Classic Bluetooth transmitter characteristics	29
5.4.9	Bluetooth Low Energy transmitter characteristics	29
6	Mechanical specifications	30
6.1	Dimensions	30
6.2	Module weight	31
7	Qualification and approvals	32
7.1	Compliance with the RoHS directive	32
7.2	European Union regulatory compliance	32
7.3	Safety compliance	32
7.4	FCC and IC Compliance	32
7.4.1	IC compliance	32
7.4.2	Conformité aux orms d'IC	33
7.4.3	FCC statement	33
7.4.4	Labeling requirements for end product	34
7.5	Japan radio equipment compliance	35
7.6	SRRRC China Radio Transmission Equipment Type Approval	36
7.6.1	ODIN-W262 labeling requirements for end product	36
7.7	NCC Taiwan compliance	36
7.7.1	Taiwan NCC Warning Statement	36
7.7.2	ODIN-W260 labeling requirements for end product	36
7.7.3	ODIN-W262 labeling requirements for end product	37
7.8	Korean KCC certification	37
7.9	Brazil compliance	37
7.10	Australia and New Zealand regulatory compliance	38
7.11	South Africa regulatory compliance	38
7.12	Bluetooth qualification information	39
8	Antennas	40
8.1	Antenna accessories	41

8.2	Approved antennas	41
8.2.1	Single band antennas	41
8.2.2	Dual-band antennas.....	43
9	Product handling and soldering	45
9.1	Packaging	45
9.1.1	Reels	45
9.1.2	Tapes.....	45
9.2	Moisture sensitivity levels.....	46
9.3	Reflow soldering	46
9.4	ESD precautions.....	46
10	Labeling and ordering information	47
10.1	Label information	47
10.2	Explanation of codes	48
10.3	Ordering information.....	48
Appendix	49
A	Glossary	49
Related documents	51
Revision history	52
Contact	53

1 Functional description

1.1 Overview

The ODIN-W2 is a compact and powerful stand-alone multi-radio module, designed for Internet-of-Things gateway applications. The module includes an embedded Bluetooth stack, Wi-Fi driver, IP stack, and an application for wireless data transfer, all configurable using AT commands. The wireless support includes dual-mode Bluetooth v4.2 (BR/EDR and low energy) and dual-band Wi-Fi (2.4 and 5 GHz bands).

The module supports point-to-point and point-to-multipoint configurations and can have concurrent Bluetooth and Wi-Fi connections. It can operate in Wireless Multidrop™ or Extended Data Mode for advanced multipoint capabilities. Operation in Point-to-Point Protocol (PPP) mode gives the host a UART-based IP interface for advanced use cases. The software provides support for RMod with a micro Access Point.

The module is professional grade with an extended temperature range and is radio type approved for multiple countries, which reduces the integration work and cost.

1.2 Applications

- Internet of Things (IoT)
- Wi-Fi and Bluetooth networks
- Medical and industrial networking
- Access to laptops, mobile phones, and similar consumer devices
- Home/building automation
- Ethernet/Wireless Gateway

1.3 Product features

	ODIN-W260		ODIN-W262/ ODIN-W263	
Grade				
Automotive				
Professional	•		•	
Standard				
Radio				
Bluetooth qualification	v4.2			
Bluetooth profiles	SPP, DUN, PAN, GATT			
Bluetooth BR/EDR	•		•	
Bluetooth low energy	•		•	
Bluetooth output power EIRP [dBm]	14		11	
Wi-Fi 2.4 / 5 [GHz]	2.4 and 5		2.4 and 5	
Wi-Fi IEEE 802.11 standards	a/b/g/n		a/b/g/n	
Wi-Fi output power EIRP [dBm]	18		15	
Max Wi-Fi range [meters]	300		250	
Antenna type	c		i	
Application software				
u-connectXpress software	•		•	
Open CPU for embedded customer applications		•		•
Interfaces				
UART	1	◆	1	◆
SPI		◆		◆
I ² C		◆		◆
I ² S				
RMII	1	◆	1	◆
GPIO pins	23	29	23	29
AD converters (ADC)		◆		◆
Features				
AT command interface	•		•	
Point-to-Point Protocol	•		•	
Extended Data Mode	•		•	
Low Energy Serial Port Service	•		•	
Wi-Fi throughput [Mbit/s]	20		20	
Maximum Bluetooth connections	7		7	
Micro Access Point [max stations]	10		10	
Wi-Fi enterprise security	•		•	
End-to-end security (TLS)	•		•	
WPA/WPA2	•		•	

c = U.FL connector(s) for externa antenna

◆ = Feature enabled by HW. The actual support depends on the open CPU application SW.

Table 1: Key features of ODIN-W2 series

1.4 Block diagram

Figure 1 shows the block diagram for the ODIN-W2 module .

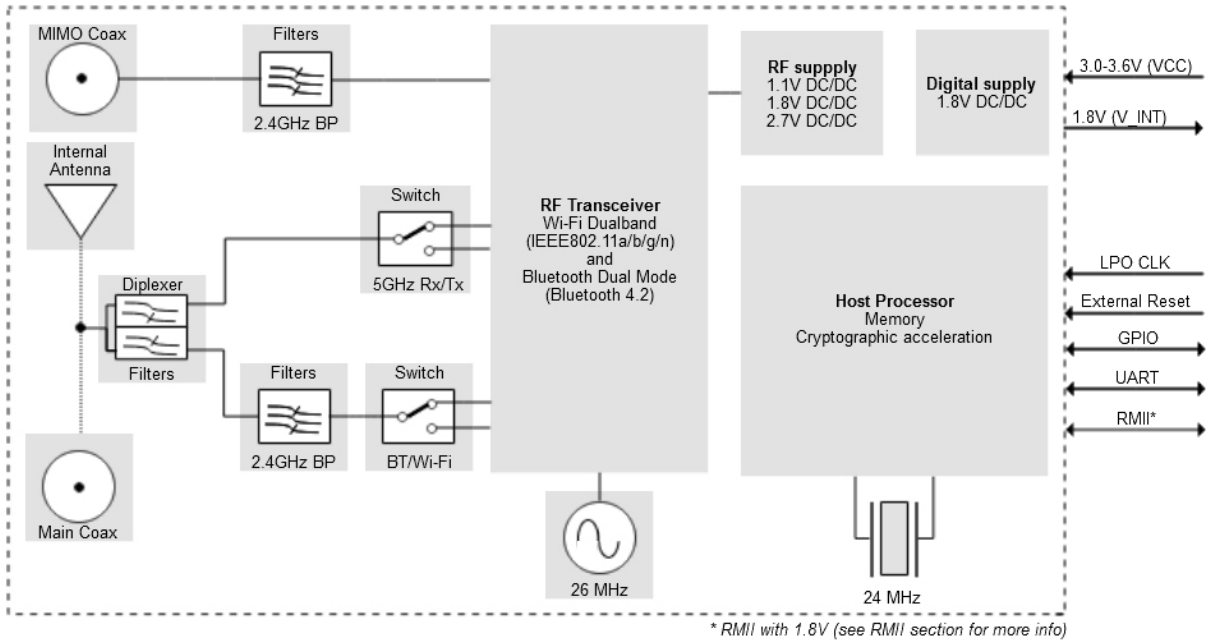

Figure 1: ODIN-W2 series block diagram

1.5 Product description

The ODIN-W2 series module supports Wi-Fi, Bluetooth BR/EDR, and Bluetooth Low Energy (dual-mode / Bluetooth Smart Ready). The Wi-Fi support conforms to IEEE 802.11a/b/g/n and has support for dual-band 2.4 GHz and 5 GHz operations and 2x2 MIMO (2.4 GHz).

Wi-Fi	Classic Bluetooth	Bluetooth Low Energy
IEEE 802.11 ^o /b/g/n IEEE 802.11d/e/i/h/w ^{***} ODIN-W260: 2X2 MIMO (2.4 GHz only)	Classic Bluetooth v2.1+EDR Maximum number of Peripherals: 7 Bluetooth profiles: SPP, DUN, GATT and PAN	Bluetooth LE 4.2 dual-mode
Band support Station mode: 2.4 GHz, channel 1-13 [*] 5 GHz, channel 36-165 [*] Access Point mode: 2.4 GHz, channel 1-11 5 GHz, channel 36-48	Band support 2.4 GHz, 79 channels	Band support 2.4 GHz, 40 channels
Maximum conducted output power 15 dBm	Maximum conducted output power 11 dBm	Maximum conducted output power 7 dBm
Maximum radiated output power 18 dBm EIRP ^{**}	Maximum radiated output power 14 dBm EIRP ^{**}	Maximum radiated output power 10 dBm EIRP ^{**}
Conducted sensitivity 2.4 GHz: -95 dBm 5 GHz: -90 dBm	Conducted sensitivity -90 dBm	Conducted sensitivity -95 dBm
Data rates: IEEE 802.11b: 1 / 2 / 5.5 / 11 Mbit/s IEEE 802.11a/g: 6 / 9 / 12 / 18 / 24 / 36 / 48 / 54 Mbit/s IEEE 802.11n SISO: MCS 0-7, HT20 (6.5-65 Mbit/s) IEEE 802.11n 2x2 MIMO: MCS 8-15, HT20 (13-130 Mbit/s)	Data rates: 1 / 2 / 3 Mbit/s	Data rates: 1 Mbit/s

^{*} Maximum, supports 802.11d and depends on region.

^{**} RF power including maximum antenna gain (3 dBi).

^{***} DFS client only.

Table 2: ODIN-W2 series Wi-Fi and Bluetooth characteristics

1.6 AT command support

You can configure ODIN-W2 with the u-blox s-center toolbox software using AT commands. See also the u-connectXpress AT commands manual [\[1\]](#).

The s-center evaluation software [\[5\]](#) supporting the AT commands is also available free of charge and can be downloaded from the u-blox website.

1.7 IEEE 802.11d and additional regulatory domains

The ODIN-W2 series modules support IEEE 802.11d. IEEE 802.11d is an amendment to the IEEE 802.11 specification that adds support for “additional regulatory domains”. IEEE 802.11d allows ODIN-W2 based devices to self-configure and operate according to the regulations of the country in which they operate. Its parameters include country name, channel quantity and maximum transmission level. The country information feature simplifies the creation of 802.11 wireless access points and client devices that meet the different regulations enforced in various parts of the world.

1.7.1 ODIN-W2 IEEE 802.11d implementation description

When ODIN-W2 is used as a Wi-Fi station, the scan is used to detect which regulatory domain it is currently in. Passive scan is used for channels that are not available in all regulatory domains. The device supports the following three domains, where WORLD means all channels that are supported both by FCC, ETSI and most other countries in the world:

- WORLD
- FCC
- ETSI

⚠ ODIN-W263 is configured to always support the ETSI domain and is only allowed to be used in countries allowing ETSI domain channels, as shown in [Table 3](#).

[Table 3](#) shows the channels that are supported in the different regulatory domains. [Figure 2](#) shows a state transition diagram describing the algorithm for selecting the current regulatory domain.

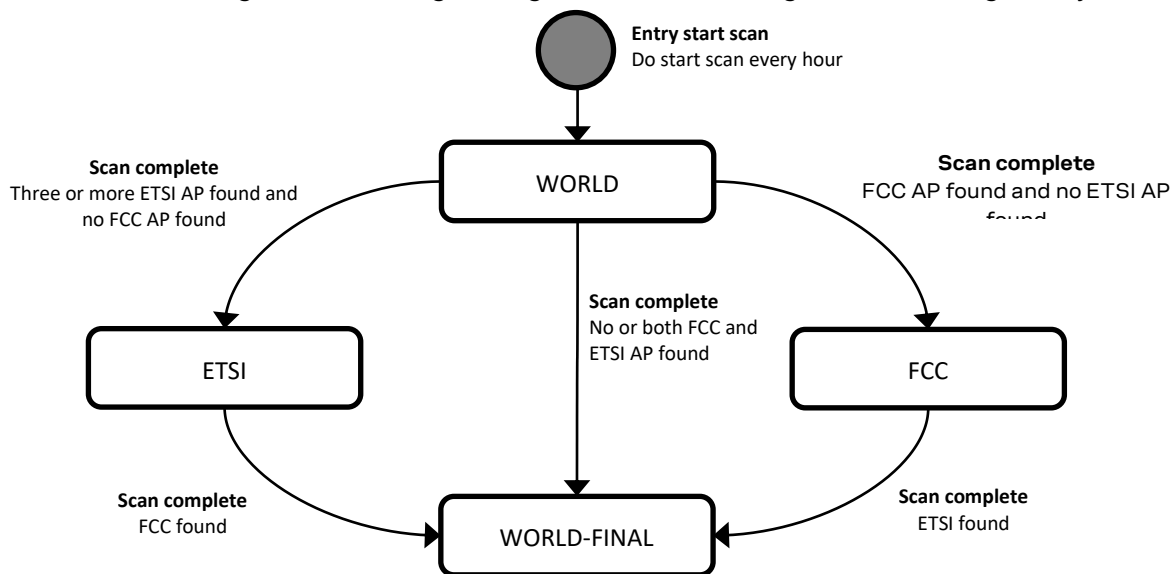

Figure 2: ODIN-W2 series IEEE 802.11d state transition diagram

Initial regulatory domain is WORLD. At start up a scan is initiated to detect beacons containing country information.

If at least one scan result contains country information indicating FCC and no country information indicates ETSI, then the regulatory domain is set to FCC.

If at least three scan results contain country information indicating ETSI and no country information indicates FCC, then the regulatory domain is set to ETSI.

If the scan result contains country information indicating both FCC and country information indicating ETSI, then the regulatory domain is set to WORLD. In the state transition diagram this is the state WORLD_FINAL. This state will not be exited until the device is reset.

A new scan is performed every hour to update the regulatory domain.

If the current regulatory domain is ETSI and at least one scan result contains country information indicating FCC and then the regulatory domain is set to WORLD. In the state transition diagram this is the state WORLD-FINAL. This state is will not be exited until the device is reset.

If the current regulatory domain is FCC and at least one scan result contains country information indicating ETSI and then the regulatory domain is set to WORLD. In the state transition diagram this is the state WORLD-FINAL. This state is will not be exited until the device is reset.

At restart of the device the algorithm is restarted. It is not possible to override the algorithm described by reconfiguration the device.

Regulatory domain	Band	Tx channels
WORLD	2.4 GHz	1, 2, 3, 4, 5, 6, 7, 8, 9, 10, 11
	U-NII-1	36, 40, 44, 48
	U-NII-2	52, 56, 60, 64
	U-NII-2e	100, 104, 108, 112, 116, 132, 136, 140
	U-NII-3	-
ETSI	2.4 GHz	1, 2, 3, 4, 5, 6, 7, 8, 9, 10, 11, 12, 13
	U-NII-1	36, 40, 44, 48
	U-NII-2	52, 56, 60, 64
	U-NII-2e	100, 104, 108, 112, 116, 120, 124, 128, 132, 136, 140
	U-NII-3	149, 153, 157, 161, 165
FCC	2.4 GHz	1, 2, 3, 4, 5, 6, 7, 8, 9, 10, 11
	U-NII-1	36, 40, 44, 48
	U-NII-2	52, 56, 60, 64
	U-NII-2e	100, 104, 108, 112, 116, 132, 136, 140
	U-NII-3	149, 153, 157, 161, 165

Table 3: Channel list for supported regulatory domains

The maximum output power is reduced on some channels depending on regulatory requirements. For example, frequency band edge requirements can limit the output power on channels close to band edges.

1.8 MAC addresses

ODIN-W2 module series has four unique consecutive MAC addresses reserved for each module, from which the three first addresses are stored in the configuration memory during production. The first Bluetooth MAC address is available in the Data Matrix on the label. See also [Label information](#). The last MAC address is not stored in the configuration memory but is reserved for usage with the module.

MAC address	Assignment	Example
Address 1	Bluetooth	<i>D4:CA:6E:90:04:90</i>
Address 2	Wi-Fi	<i>D4:CA:6E:90:04:91</i>
Address 3	RMII/Ethernet	<i>D4:CA:6E:90:04:92</i>
Address 4	Reserved	<i>D4:CA:6E:90:04:93</i>

Table 4: Example MAC address assignment for an ODIN-W2 module

2 Interfaces

-  ODIN-W2 is a surface mounted device (SMD). As the ports supported in the module are not tested against fast transients, RF common mode, transients and surge, the module must not be connected with cables longer than 3 m.

2.1 Power management

-  To fulfill EN 60950-1 safety standards, the unit must be supplied by a limited power source.

2.1.1 Module supply input (VCC)

ODIN-W2 series modules must be supplied through the **VCC** pin by a DC power supply. Voltage must be stable, because during operation the current drawn from VCC can vary significantly based on the power consumption profile of the Bluetooth/Wi-Fi technologies.

2.1.2 Digital I/O interfaces supply output (V_INT)

The ODIN-W2 series modules provide a 1.8 V supply rail output on the **V_INT** pin, which is internally generated when the module is powered on. The same voltage domain is used internally to supply the generic digital interfaces of the modules. The **V_INT** supply output can be used instead of an external discrete regulator. For maximum output current, see the [Electrical specification](#).

2.2 Antenna interfaces

The following two different antenna options are available in the ODIN-W2 series:

- ODIN-W260 is equipped with dual U.FL. coaxial connectors for external antennas. Different types of external antennas are available and can be used.
- ODIN-W262 and ODIN-W263 is equipped with an integrated dual-band antenna

-  While mounting the unit, ensure that it does not interfere with radio communication. The ODIN-W262 and ODIN-W263 equipped with an internal surface mounted antenna should not be mounted in a metal enclosure. No metal casing or plastics using metal flakes should be used. Avoid metallic based paint or lacquer.

See the [Antennas](#) section for information on the external antennas that can be used and for other RF and antenna design devices. For more info about antenna integration, see the ODIN-W2 series system integration manual [\[1\]](#).

2.2.1 Antenna connectors and internal antenna

ODIN-W260 has two RF antenna U.FL. coaxial connectors with a characteristic impedance of 50 Ω . The main antenna connector supports both Bluetooth and dual-band Wi-Fi. The second (MIMO) antenna connector adds support for 2x2 MIMO 2.4 GHz single band Wi-Fi.

ODIN-W262 has an internal dual-band PIFA antenna and supports Bluetooth and dual-band Wi-Fi (SISO).

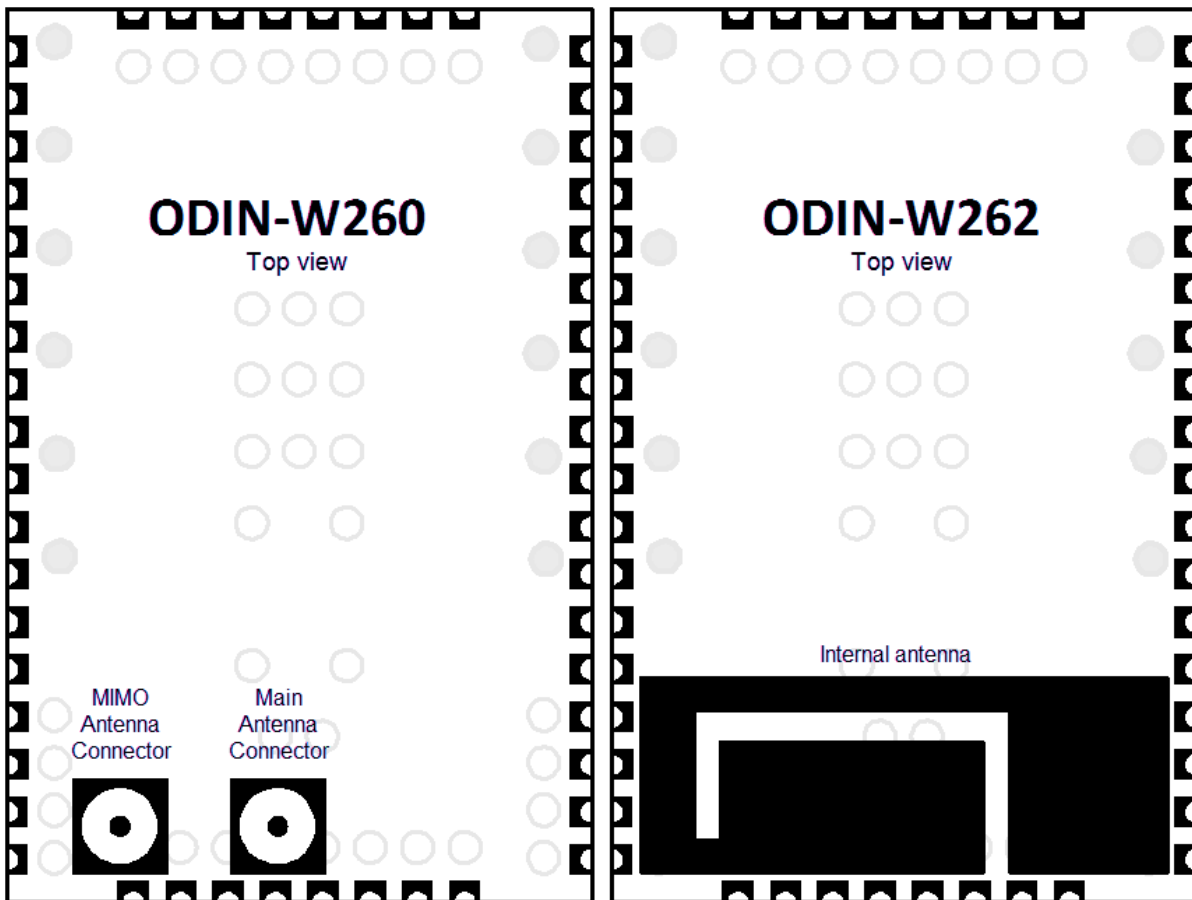

Figure 3: ODIN-W260 with connectors for external antennas and ODIN-W262 with an internal antenna

2.3 Data communication interfaces

The ODIN-W2 series provides several data communication interfaces which are described below.

2.3.1 UART interface

ODIN-W2 series modules include a 6-wire UART for communication with an application host processor (AT commands, data communication and software upgrades).

The following UART signals are available:

- Data lines (**RXD** as input, **TXD** as output)
- Hardware flow control lines (**CTS** as input, **RTS** as output)
- Link status (**DTR** as output, **DSR** as input)

CMOS compatible signal levels are recommended. For more information about the UART interface, see the u-connectXpress AT commands manual [1] and ODIN-W2 series system integration manual [2].

2.3.2 Ethernet interface

ODIN-W2 series modules include an integrated Ethernet MAC to communicate with other networked nodes over a shared medium. It supports 10/100 Mbit/s communication and can operate in both full- and half-duplex (CSMA/CD).

The Ethernet interface includes:

- RMII either for MAC to PHY or Ethernet MAC to MAC communication.
- SMI for PHY configuration

 The IO voltage of the ODIN-W2 is 1.8 V, which means that the RMII interface operates outside the RMII specification v1.2. If the RMII is to be connected to a PHY circuit, then that circuit must support 1.8 V operation. If a direct RMII to RMII connection is used, then a level shifter might be needed depending on the selected host. The selected hardware setup must be verified on the application board to guarantee operation.

2.3.2.1 RMII

The RMII uses seven signals in total. The interface requires an external 50 MHz clock source either from a compatible PHY chip or an external oscillator. ODIN-W2 cannot provide this clock signal by itself.

2.3.2.2 SMI (MDC/MDIO management interface)

The two-wire SMI is used to configure the PHY chips. The interface uses a clock line and a data line to clock data to and from the PHY chips registers.

3 System functions

3.1 Module power modes

The ODIN-W2 series module does not have an internal low power oscillator (LPO) which is required for low power modes. An external 32.768 kHz LPO signal can be supplied externally via the **LPO_CLK** pin if low power modes are required.

3.2 Module reset

The ODIN-W2 series modules can be reset (rebooted) in one of the following ways:

- Low level on the **RESET_N** pin, which is normally set high by an internal pull-up. This causes a “hardware reset” of the module. The **RESET_N** line should be driven by an open drain, open collector or contact switch.
- Using a reset AT command causes a “software reset” of the module, See also u-connectXpress AT commands manual [1]).

3.3 IO signals

3.3.1 System status IO signals

The **RED**, **GREEN** and **BLUE** pins are used to signal the status. They are active low and are intended to be routed to an RGB LED. For more information about connectivity software signal loss, see the u-connectXpress AT commands manual [1].

Mode	Status	RGB LED color	GREEN	BLUE	RED
Data mode	IDLE	Green	LOW	HIGH	HIGH
Command mode	IDLE	Orange	LOW	HIGH	LOW
Data mode, Command mode	CONNECTING*	Purple	HIGH	LOW	LOW
Data mode, Command mode	CONNECTED*	Blue	HIGH	LOW	HIGH

* = LED flashes on data activity

Table 5: System status indication

3.3.2 System control IO signals

The following input signals are used to control the system:

- **RESET_N** is used to reset the system. See also [Module reset](#).
- If **SWITCH_1** is driven low during start up, the UART serial settings are restored to their default values.
- **SWITCH_0** can be used to open a connection to a peripheral device.
- If both **SWITCH_0** and **SWITCH_1** are driven low during start up, the system will enter the bootloader mode.
- If both **SWITCH_0** and **SWITCH_1** are driven low during start up and held low for 10 seconds, the system will exit the bootloader mode and restore all settings to their factory defaults.

For more information about connectivity software signal loss, see the u-connectXpress AT commands manual [1].

3.3.3 UART IO signals

In addition to the normal **RXD**, **TXD**, **CTS**, and **RTS** signals, the ODIN-W260/ODIN-W262 software adds the **DSR** and **DTR** pins to the UART interface. Note that the DSR and DTR pins are not used as originally intended, but to control the state of the module. Depending on the current configuration, the **DSR pin** can be used to:

- Enter command mode
- Disconnect and/or toggle connectable status

4 Pin definition

4.1 Pin assignment

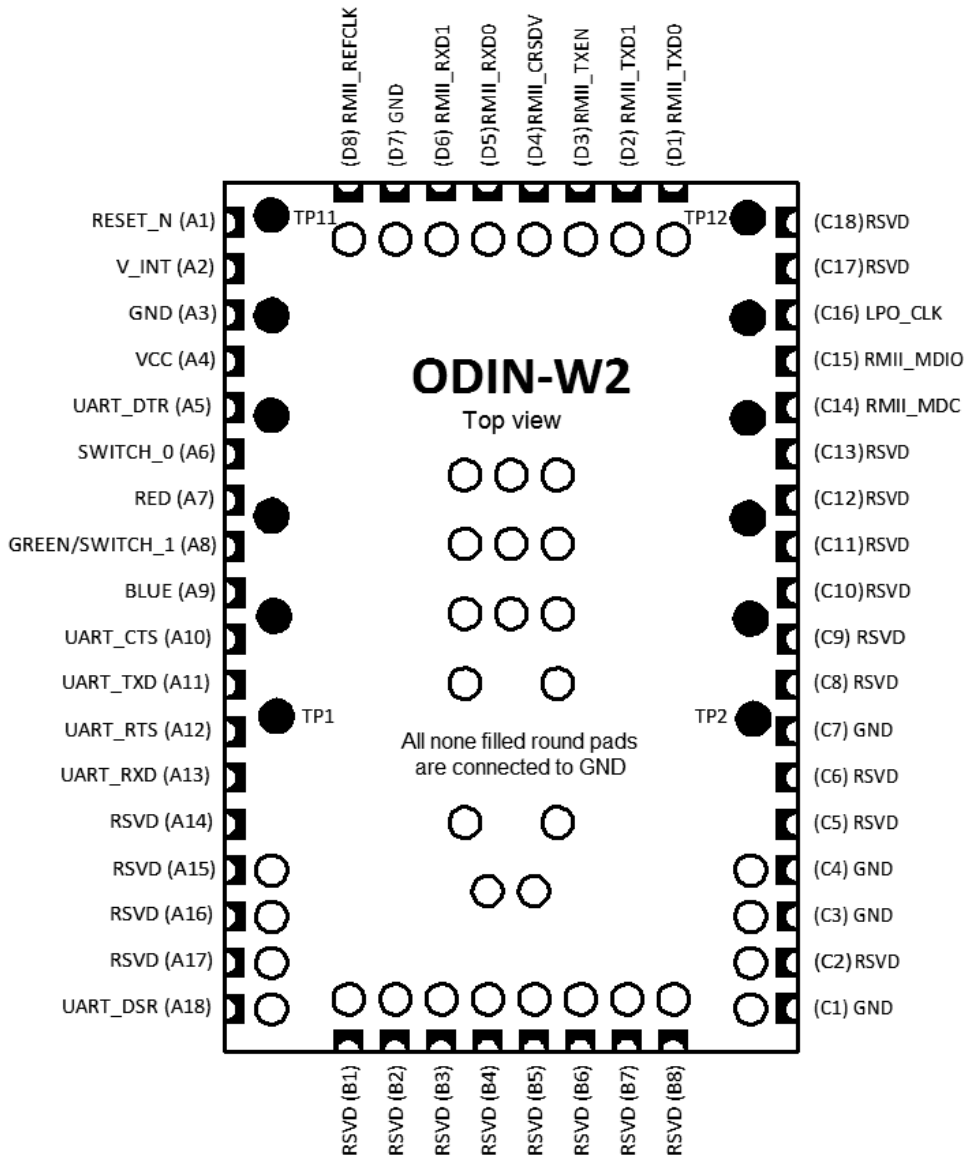

Figure 4: ODIN-W2 series pin assignment

The signals are available on castellation pads located on the edge of the PCB. All non-filled round pads are **GND** pads. Black circular pads are test and production points that should not be used. **RSVD** = Reserved, do not connect.

No	Name	I/O	Description	Remarks
A1	RESET_N	I	External reset input	Internal active pull-up to V_INT
A2	V_INT	O	Regulated output of the internal I/O voltage	1.8 V, maximum output current 100mA. The maximum output current can be limited by the internal current consumption of the V_INT rail. See also Power consumption .
A3	GND	N/A	Ground	All GND pads must be connected to ground
A4	VCC	I	Module power supply	3.0 – 3.6 V power supply
A5	UART_DTR	O	UART Data Terminal Ready	Active low. Can also be used as a System IO. For more information about the pin functionality, see also IO signals and u-connectXpress AT commands manual [1].
A6	SWITCH_0	I	Connect on external signal	Active low. A secondary function is that the module will restore all factory settings if both the SWITCH_1 and SWITCH_0 signals are low during start up. For more information about the pin functionality, see also IO signals .
A7	RED	O	Logic Red LED signal	Active low. See the IO section for more information. For more information about the pin functionality, see also IO signals .
A8	GREEN/ SWITCH_1	O/I	This signal is multiplexed: GREEN: Logic Green LED Signal. SWITCH_1: Default Serial Settings.	Active low. The GREEN signal is not valid until 500 ms after startup. See also IO signals . If the level on this pin is pulled-down during start-up, the unit goes back to default serial settings. The SWITCH_1 input is only active during the first 500 ms after startup. The module restores all factory settings if both the SWITCH_1 and SWITCH_0 signals are low during start up. For more information about the pin functionality, see also IO signals .
A9	BLUE	O	Logic Blue LED Signal	Active low. For more information about the pin functionality, see also IO signals .
A10	UART_CTS	I	UART Clear To Send, Hardware flow control	Active low
A11	UART_TXD	O	UART Transmit	
A12	UART_RTS	O	UART Request To Send, Hardware flow control.	Active low

No	Name	I/O	Description	Remarks
A13	UART_RXD	I	UART Receive	
A14	RSVD	N/A	Reserved pin	Leave unconnected
A15	RSVD	N/A	Reserved pin	Leave unconnected
A16	RSVD	N/A	Reserved pin	Leave unconnected
A17	RSVD	N/A	Reserved pin	Leave unconnected
A18	UART_DSR	I	UART Data Set Ready	Active low. Can also be used as a System IO. For more information about the pin functionality, see also IO signals and u-connectXpress AT commands manual [1] .
B1	RSVD	N/A	Reserved pin	Leave unconnected
B2	RSVD	N/A	Reserved pin	Leave unconnected
B3	RSVD	N/A	Reserved pin	Leave unconnected
B4	RSVD	N/A	Reserved pin	Leave unconnected
B5	RSVD	N/A	Reserved pin	Leave unconnected
B6	RSVD	N/A	Reserved pin	Leave unconnected
B7	RSVD	N/A	Reserved pin	Leave unconnected
B8	RSVD	N/A	Reserved pin	Leave unconnected
C1	GND	N/A	Ground	All GND pads must be connected to ground
C2	RSVD	N/A	Reserved pin	Leave unconnected
C3	GND	N/A	Ground	All GND pads must be connected to ground
C4	GND	N/A	Ground	All GND pads must be connected to ground
C5	RSVD	N/A	Reserved pin	Leave unconnected
C6	RSVD	N/A	Reserved pin	Leave unconnected
C7	GND	N/A	Ground	All GND pads must be connected to ground
C8	RSVD	N/A	Reserved pin	Leave unconnected
C9	RSVD	N/A	Reserved pin	Leave unconnected
C10	RSVD	N/A	Reserved pin	Leave unconnected
C11	RSVD	N/A	Reserved pin	Leave unconnected
C12	RSVD	N/A	Reserved pin	Leave unconnected
C13	RSVD	N/A	Reserved pin	Leave unconnected
C14	RMII_MDC	O	Management interface clock output	According to RMII specification v1.2 with the exception that voltage level is 1.8 V
C15	RMII_MDIO	I/O	Management interface data I/O	An external pull-up resistor is required on the bidirectional data signal. According to RMII specification v1.2 with the exception that voltage level is 1.8 V.

No	Name	I/O	Description	Remarks
C16	LPO_CLK	I	Low power oscillator clock input	The module requires an external 32.768 kHz clock for low power modes. Leave this pin unconnected if not used as LPO clock input.
C17	RSVD	N/A	Reserved pin	Leave unconnected
C18	RSVD	N/A	Reserved pin	Leave unconnected
D1	RMII_TXD0	O	Transmit data output 0	According to RMII specification v1.2 with the exception that voltage level is 1.8 V
D2	RMII_TXD1	O	Transmit data output 1	According to RMII specification v1.2 with the exception that voltage level is 1.8 V
D3	RMII_TXEN	O	Transmit Enable output	Active high. According to RMII specification v1.2 with the exception that voltage level is 1.8 V.
D4	RMII_CRSDV	I	Carrier sense/receive data valid input	Carrier Sense and Receive Data Valid signals are multiplexed together, multiplexing scheme varies with implementation. According to RMII specification v1.2 with the exception that voltage level is 1.8 V.
D5	RMII_RXD0	I	Receive data input 0	According to RMII specification v1.2 with the exception that voltage level is 1.8 V
D6	RMII_RXD1	I	Receive data input 1	According to RMII specification v1.2 with the exception that voltage level is 1.8 V
D7	GND	N/A	Ground	All GND pads must be connected to ground
D8	RMII_REFCLK	I	Reference Clock input	Continuous 50 MHz reference clock input. According to RMII specification v1.2 - except that voltage level is 1.8 V.

Table 6: ODIN-W2 series pin-out

5 Electrical specification

Stressing the device above one or more of the ratings listed in the [Absolute maximum ratings](#) can cause permanent damage. These are stress ratings only. Operating the module at these or at any conditions other than those specified in the [Operating conditions](#) should be avoided. Exposure to absolute maximum rating conditions for extended periods may affect device reliability.

5.1 Absolute maximum ratings

Symbol	Description	Condition	Min	Maximum	Unit
VCC	Module supply voltage	Input DC voltage at VCC pin	-0.3	5.5*	V
GDI	Generic digital interfaces	Input DC voltage at Generic digital interfaces pins	-0.3	2.2	V
ERS	External reset signal	Input DC voltage at RESET_N pin	-0.3	5.2	V
Tstg	Storage temperature		-40	+85	°C

* 5.5 V up to 10 s cumulative in 7 years, 5 V cumulative to 250 s, 4.8 V cumulative to 2.33 years – all includes charging dips and peaks.

Table 7: Absolute maximum ratings

5.1.1 Maximum ESD

Parameter	Maximum	Unit	Remarks
ESD immunity for antenna connector shielding	6000	V	Contact Discharge according to IEC 61000-4-2
	8000	V	Air Discharge according to IEC 61000-4-2
ESD indirect contact discharge	±8*	kV	According to EN 301 489-1
ESD sensitivity for all pins	1000	V	Human Body Model according to ANSI/ESDA/JEDEC JS-001
	250	V	Charged Device Model according to EIA-JEDEC JESD22-C101E

* = Tested on EVK-ODIN-W2 evaluation board.

Table 8: Maximum ESD ratings

5.2 Operating conditions

Operating condition ranges define those limits within which the functionality of the device is guaranteed.

5.2.1 Temperature range

Parameter	Min	Maximum	Unit
Storage temperature	-40	+85	°C
Operating temperature	-40	+85	°C

Table 9: Temperature range

5.2.2 Power supply

Symbol	Parameter	Min	Typ	Maximum	Unit
VCC	Supply voltage	3.00	3.30	3.60	V
V_INT	Output voltage	1.76	1.80	1.84	V
I _{VCC}	Supply voltage current drain ¹	-	-	1.0	A
I _{V_INT}	Output voltage current drain	-	-	100	mA

Table 10: Power supply voltage

5.2.3 I/O DC characteristics

Symbol	Parameter	Min	Typ	Maximum	Unit	
V _{IL}	LOW level input voltage		0	0.5	V	
V _{IH}	HIGH level input voltage	1.31	1.8	2.0	V	
V _{OL}	LOW level output voltage		0	0.4	V	
V _{OH}	HIGH level output voltage	1.34	1.8		V	
I _{IO}	I/O pin sink and source current			4.0*	mA	
C _{IO}	I/O pin input capacitance		5		pF	
R _{PU}	Internal active pull-up resistance	All IO pins except for UART_RXD	30	40	50	kΩ
		UART_RXD	8	11	15	kΩ
R _{PD}	Internal active pull-down resistance	30	40	50	kΩ	

* 8.0 mA is possible, but the output voltage level is not guaranteed.

Table 11: I/O DC characteristics

5.2.4 Reset characteristics

Symbol	Parameter	Conditions	Min	Typ	Maximum	Unit
V _{IL(RESET_N)}	RESET_N Input low level voltage				0.5	V
V _{IH(RESET_N)}	RESET_N Input high level voltage		1.3			V
V _{hys(RESET_N)}	RESET_N Schmitt trigger voltage hysteresis			200		mV
R _{PU(RESET_N)}	Internal RESET_N pull-up resistance			8		kΩ
C _{RESET_N}	Internal RESET_N capacitance			100		nF
V _{F(RESET_N)}	RESET_N Input filtered pulse				100	ns

Table 12: Reset characteristics

¹ See Power consumption section for detailed information.

5.2.5 LPO clock

The ODIN-W2 series module does not have an internal low power oscillator (LPO) required for low power modes. An LPO can be supplied from an external oscillator if low power modes are required.

Symbol	Parameter	Min	Typ	Maximum	Unit
LPO _{32.768KHz}	Input clock frequency		32.768		kHz
	Input slow clock accuracy (Initial + temp + aging)			±150	ppm
Tr/Tf	Input transition time Tr/Tf -10% to 90%			100	ns
	Frequency input duty cycle	20	50	80	%
V _{IH}	Input voltage limits (Square wave, DC-coupled)	1.31		1.8	V
V _{IL}		0		0.5	V
	Input capacitance			10	pF

Table 13: External LPO clock characteristics

5.2.6 Universal asynchronous serial interface (UART)

Symbol	Parameter	Min	Typ	Maximum	Unit
f _{baud}	Baud rate	2400	115200	5.25M	bit/s

Table 14: UART characteristics

5.3 Power consumption

5.3.1 General power consumption

V_{CC} = 3.3 V, T_A = 25 °C unless otherwise specified.

Symbol	Parameter	Conditions	Average	Peak	Unit
I _{DD}	Supply current	Reset	5.2	6.0	mA
		Startup	300	450*	mA
		Idle, not connected, default configuration	30	65	mA
		Idle, not connected, no running services**	30	60	mA
		Stop mode***	TBD	TBD	mA
I _{DD_MAXIMUM}	Absolute maximum current drain		-	800	mA

* Wi-Fi and Bluetooth calibration during the startup phase causes large, short current peaks.

** No server running and Bluetooth Connectable and Discoverable turned off.

*** Feature not supported in the current software version. For more information See the u-connectXpress AT commands manual [1] .

Table 15: General current consumption

5.3.2 Wi-Fi 2.4 GHz power consumption

$V_{CC} = 3.3\text{ V}$, $T_A = 25\text{ °C}$ unless otherwise specified.

Symbol	Parameter	Conditions	Average	Peak	Unit
I_{DDW24}	Supply current not connected	Scan, 11 channels, 300 ms	100	360	mA
		Idle, Connected DTIM = 1, $T_{\text{beacon}} = 100\text{ ms}$	36	100	mA
		Idle, Connected DTIM = 5, $T_{\text{beacon}} = 100\text{ ms}$	32	100	mA
I_{DDW24_TX}	Supply current transmitting	802.11b, 1Mb/s, transmission duty cycle 70-75%	250	350	mA
		802.11g, 6Mb/s, transmission duty cycle 25-30%	190	360	mA
		802.11n SISO, MCS0, transmission duty cycle 25-30%	190	360	mA
		802.11n MIMO, MCS8, transmission duty cycle 15-20%	220	650	mA
I_{DDW24_RX}	Supply current receiving	802.11b	110	130	mA
		802.11g	110	130	mA
		802.11n SISO	110	130	mA
		802.11n MIMO	140	160	mA

Table 16: Current consumption for Wi-Fi 2.4 GHz

5.3.3 Wi-Fi 5 GHz power consumption

$V_{CC} = 3.3\text{ V}$, $T_{\text{amb}} = 25\text{ °C}$

Symbol	Parameter	Conditions	Average	Peak	Unit
I_{DDW5}	Supply current not connected	Scan, 4 channels, 100 ms	100	370	mA
		Idle, Connected DTIM = 1, $T_{\text{beacon}} = 100\text{ ms}$	36	100	mA
		Idle, Connected DTIM = 5****, $T_{\text{beacon}} = 100\text{ ms}$	32	100	mA
I_{DDW5_TX}	Supply current transmitting	802.11a, 6Mb/s, transmission duty cycle 25-30%	200	370	mA
		802.11n SISO, 6.5Mb/s, transmission duty cycle 25-30%	200	370	mA
I_{DDW5_RX}	Supply current receiving	802.11a	120	130	mA
		802.11n SISO	120	130	mA

* * Very short peaks during start of transmission.

Table 17: Current consumption for Wi-Fi 5 GHz

5.3.4 Classic Bluetooth power consumption

$V_{CC} = 3.3\text{ V}$, $T_{\text{amb}} = 25\text{ °C}$

Symbol	Parameter	Conditions	Average	Peak	Unit
I_{DDBT_NDNC}	Supply current not connected	Not discoverable, Not connectable	30	65	mA
I_{DDBT_NDC}		Not discoverable, Connectable, scan interval = TBD, scan window = TBD	30	65	mA
I_{DDBT_DC}		Discoverable, Connectable, scan interval = TBD, scan window = TBD	30	65	mA
I_{DDBT_INQ}	Supply current inquiry		47	120	mA
I_{DDBT_IDLE}	Supply current connected	Idle	32	120	mA
I_{DDBT_TX1Mb}		Transmitting	56	120	mA
I_{DDBT_RX1Mb}		Receiving	46	120	mA

Table 18: Current consumption for classic Bluetooth

5.3.5 Bluetooth Low Energy (LE) power consumption

$V_{CC} = 3.3\text{ V}$, $T_{amb} = 25\text{ °C}$

Symbol	Parameter	Conditions	Average	Peak	Unit	
$I_{DDBLE_CD_NC}$	Supply current not connected	Central device	Idle	29	65	mA
$I_{DDBLE_CD_INQ}$			Low Energy Inquiry	48	80	mA
$I_{DDBLE_PD_NC}$		Peripheral device	Idle	29	65	mA
$I_{DDBLE_PD_ADV}$			Advertising	29	65	mA
$I_{DDBLE_CD_IDL}$	Supply current connected	Central device	Idle	44	100	mA
$I_{DDBLE_CD_TX}$			Transmitting	45	100	mA
$I_{DDBLE_CD_RX}$			Receiving	45	100	mA
$I_{DDBLE_PD_IDL}$		Peripheral device	Idle	29	100	mA
$I_{DDBLE_PD_TX}$			Transmitting	30	100	mA
$I_{DDBLE_PD_RX}$			Receiving	30	100	mA

Table 19: Current consumption for Bluetooth Low Energy (LE)

5.4 RF characteristics

5.4.1 Wi-Fi radio characteristics

$V_{CC} = 3.3\text{ V}$, $T_{amb} = 25\text{ °C}$

Parameter	Operation Mode	Specification	Unit
RF Frequency Range	802.11b/g/n	2.400 – 2.500	GHz
	802.11a/n	5.180 – 5.825	GHz
Channels	802.11b/g/n	1-13*	
	802.11a/n	36-165*	
Modulation	802.11b	CCK and DSSS	
	802.11a/g/n	OFDM	
Supported Data Rates	802.11b	1, 2, 5.5, 11	Mbps
	802.11a/g	6, 9, 12, 18, 24, 36, 48, 54	Mbps
	802.11n	MCS0 – MCS15	
Supported Bandwidth	802.11n	20	MHz

* Maximum supported channels for 802.11d depends on the region.

Table 20: General Wi-Fi characteristics

5.4.2 Wi-Fi receiver characteristics 2.4 GHz

$V_{CC} = 3.3\text{ V}$, $T_{amb} = 25\text{ °C}$

Parameter	Conditions	Antenna port	Channel / Freq [MHz]	IEEE limit	Typ*	Unit
Receive sensitivity	802.11b, Rate = 1 Mbit/s, PER ≤ 8%	MAIN port	6 / 2437	-76	-95	dBm
	802.11b, Rate = 11 Mbit/s, PER ≤ 8%	MAIN port	6 / 2437	-76	-86	dBm
	802.11g, Rate = 6 Mbit/s, PER ≤ 10%	MAIN port	6 / 2437	-82	-90	dBm
	802.11g, Rate = 54 Mbit/s, PER ≤ 10%	MAIN port	6 / 2437	-65	-72	dBm

Parameter	Conditions	Antenna port	Channel / Freq [MHz]	IEEE limit	Typ*	Unit
	802.11n SISO, MCS0, PER ≤ 10%	MAIN port	6 / 2437	-82	TBD	dBm
	802.11n MIMO, MCS8, PER ≤ 10%	MAIN port	6 / 2437	-82	TBD	dBm
	802.11n MIMO, MCS8, PER ≤ 10%	MIMO port	6 / 2437	-82	TBD	dBm
	802.11n SISO, MCS7, PER ≤ 10%	MAIN port	6 / 2437	-64	TBD	dBm
	802.11n MIMO, MCS15, PER ≤ 10%	MAIN port	6 / 2437	-64	TBD	dBm
	802.11n MIMO, MCS15, PER ≤ 10%	MIMO port	6 / 2437	-64	TBD	dBm

* Measured conducted on ODIN-W260, measurement tolerance ±1.0 dB.

Table 21: Receiver characteristics for 2.4 GHz Wi-Fi

5.4.3 Wi-Fi receiver characteristics 5 GHz

$V_{CC} = 3.3\text{ V}$, $T_{amb} = 25\text{ °C}$

Parameter	Conditions	Channel / Freq [MHz]	IEEE limit	Typ*	Unit
Receive sensitivity	802.11a, Rate = 6 Mbit/s, PER ≤ 10%	36 / 5180	-82	-90	dBm
		100 / 5500	-82	-90	dBm
		140 / 5700	-82	-90	dBm
	802.11n SISO, MCS0, PER ≤ 10%	36 / 5180	-82	TBD	dBm
		100 / 5500	-82	TBD	dBm
		140 / 5700	-82	TBD	dBm
	802.11a, Rate = 48 Mbit/s, PER ≤ 10%	36 / 5180	-66	-72	dBm
		100 / 5500	-66	-72	dBm
		140 / 5700	-66	-72	dBm
802.11n SISO, MCS7, PER ≤ 10%	36 / 5180	-64	TBD	dBm	
	100 / 5500	-64	TBD	dBm	
	140 / 5700	-64	TBD	dBm	

* Measured conducted on ODIN-W260, measurement tolerance ±1.0 dB.

Table 22: Receiver characteristics for 5 GHz Wi-Fi

5.4.4 Wi-Fi transmitter characteristics 2.4 GHz

$V_{CC} = 3.3\text{ V}$, $T_{amb} = 25\text{ °C}$

Parameter	Conditions	Antenna port	Channel / Freq [MHz]	IEEE EVM limit	EVM*	Typ*	Unit
Transmitting output power	802.11b, Rate = 1 Mbit/s	MAIN port	6 / 2437	-14	-28	11.2	dBm
	802.11b, Rate = 11 Mbit/s	MAIN port	6 / 2437	-14	-26	11.3	dBm
	802.11g, Rate = 6 Mbit/s	MAIN port	6 / 2437	-5	-21	14.2	dBm
	802.11g, Rate = 54 Mbit/s	MAIN port	6 / 2437	-25	-29	12.1	dBm
	802.11n SISO, MCS0	MAIN port	6 / 2437	-5	-22	14.4	dBm
	802.11n MISO, MCS8	MAIN port	6 / 2437	-5	-28	11.5	dBm
	802.11n MISO, MCS8	MIMO port	6 / 2437	-5	-25	13.0	dBm
	802.11n SISO, MCS7	MAIN port	6 / 2437	-28	-29	12.0	dBm
	802.11n MISO, MCS15	MIMO port	6 / 2437	-28	-29	9.3	dBm
802.11n MISO, MCS15	MIMO port	6 / 2437	-28	-30	12.0	dBm	

* Measured conducted on ODIN-W260 with maximum output power, measurement tolerance ± 1.0 dB.
Regional power limitation can reduce the maximum output power (especially on channels close to band edges).

Table 23: Wi-Fi transmitter characteristics 2.4 GHz

5.4.5 Wi-Fi transmitter characteristics 5 GHz

$V_{CC} = 3.3$ V, $T_{amb} = 25$ °C

Parameter	Conditions	Channel / Freq [MHz]	IEEE EVM limit	EVM*	Typ*	Unit
Transmitting output power	802.11a, Rate = 6 Mbit/s	40 / 5180	-5	-26	12.8	dBm
		100 / 5500	-5	-25	12.8	dBm
		140 / 5700	-5	-26	13.7	dBm
	802.11a, Rate = 54 Mbit/s	40 / 5180	-25	-26	12.7	dBm
		100 / 5500	-25	-25	12.1	dBm
		140 / 5700	-25	-25	13.2	dBm
	802.11n SISO, MCS0	40 / 5180	-5	-23	13.1	dBm
		100 / 5500	-5	-22	13.2	dBm
		140 / 5700	-5	-18	13.3	dBm
	802.11n SISO, MCS7	40 / 5180	-28	-29	13.1	dBm
		100 / 5500	-28	-28	13.2	dBm
		140 / 5700	-28	-28	13.3	dBm

* Measured conducted on ODIN-W260 with maximum output power, measurement tolerance ± 1.0 dB.
Regional power limitation can reduce the maximum output power (especially on channels close to band edges).

Table 24: Wi-Fi transmitter characteristics 5 GHz

5.4.6 Classic Bluetooth receiver characteristics

$V_{CC} = 3.3$ V, $T_{amb} = 25$ °C

Parameter	Conditions	Limit	Typ*	Min*	Unit
Rx sensitivity	BR 1Mbit, GFSK, BER $\leq 0.1\%$	-70	-90		dBm
	EDR 2Mbit, $\pi/4$ -DQPSK, BER $\leq 0.007\%$	-70	-90		dBm
	EDR 3Mbit, 8DPSK, BER $\leq 0.007\%$	-70	-83		dBm
Maximum input level	BR 1Mbit, GFSK, BER $\leq 0.1\%$	-20		-6	dBm
	EDR 2Mbit, $\pi/4$ -DQPSK, BER $\leq 0.1\%$	-20		-10	dBm
	EDR 3Mbit, 8DPSK, BER $\leq 0.1\%$	-20		-10	dBm

* Measured conducted on ODIN-W260, measurement tolerance ± 1.0 dB.

Table 25: Classic Bluetooth receiver sensitivity

5.4.7 Bluetooth Low Energy receiver sensitivity

$V_{CC} = 3.3$ V, $T_{amb} = 25$ °C

Parameter	Conditions	Limit	Typ*	Min*	Unit
Rx sensitivity	PER $\leq 30.8\%$	-70	-95		dBm
Maximum input level	PER $\leq 30.8\%$	-10		-6	dBm

* Measured conducted on ODIN-W260, measurement tolerance ± 1.0 dB.

Table 26: Bluetooth Low Energy receiver sensitivity

5.4.8 Classic Bluetooth transmitter characteristics

$V_{CC} = 3.3\text{ V}$, $T_{amb} = 25\text{ °C}$

Parameter	Conditions	Typ*	Max*	Unit
Transmitting output power	BR 1Mbit, GFSK	11.0	11.4	dBm
	EDR 2Mbit, $\pi/4$ -DQPSK	6.5	7.0	dBm
	EDR 3Mbit, 8DPSK	6.5	7.0	dBm

* Measured conducted on ODIN-W260, measurement tolerance $\pm 1.0\text{ dB}$.

Table 27: Bluetooth transmitter output power

5.4.9 Bluetooth Low Energy transmitter characteristics

$(V_{CC} = 3.3\text{ V}, T_{amb} = 25\text{ °C})$

Parameter	Test conditions	Typ*	Max*	Unit
Transmitting output power		6.0	7.0	dBm

* Measured conducted on ODIN-W260, measurement tolerance $\pm 1.0\text{ dB}$.

Table 28: Bluetooth Low Energy transmitter characteristics

6 Mechanical specifications

6.1 Dimensions

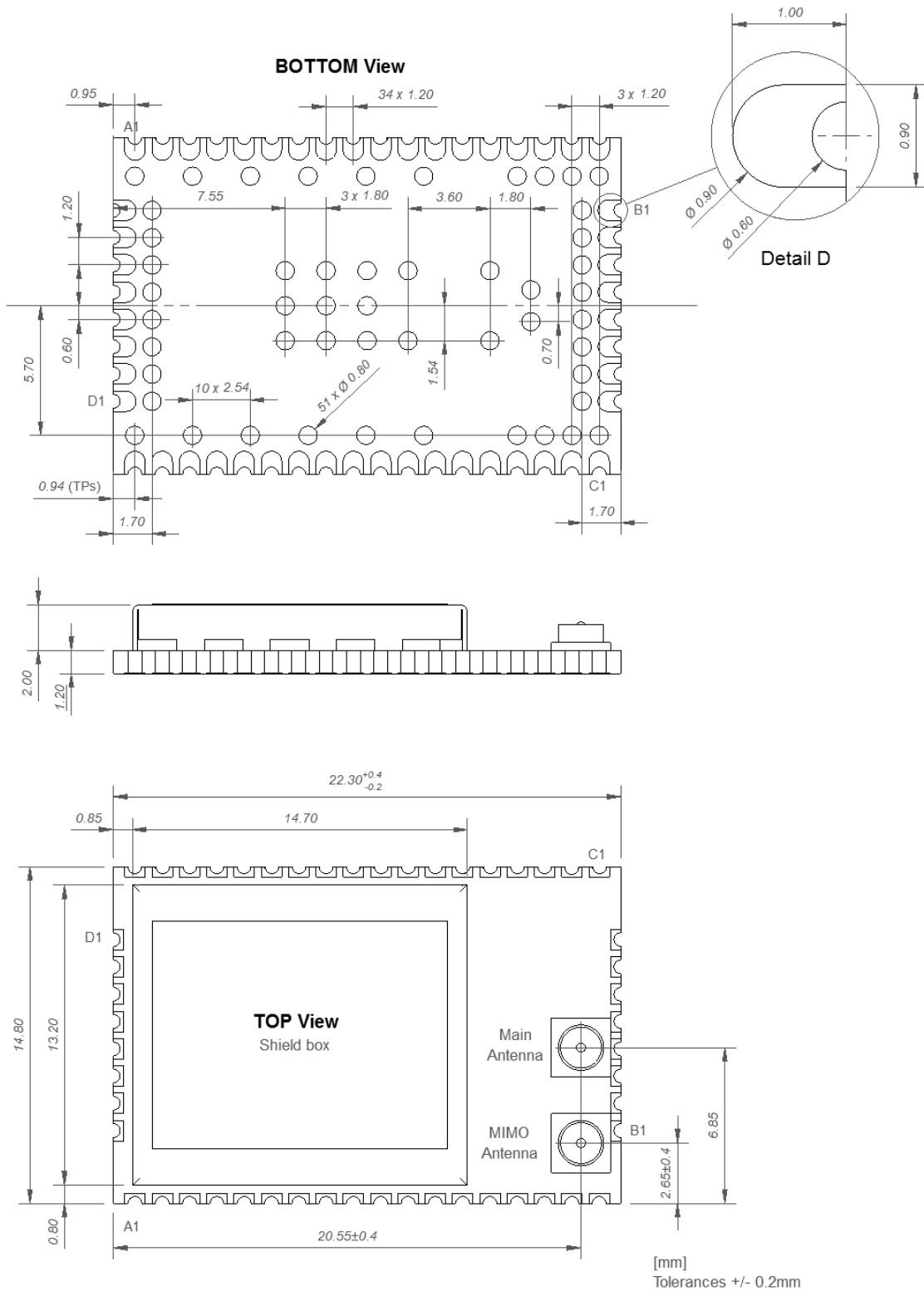

Figure 5: Physical dimensions of ODIN-W260

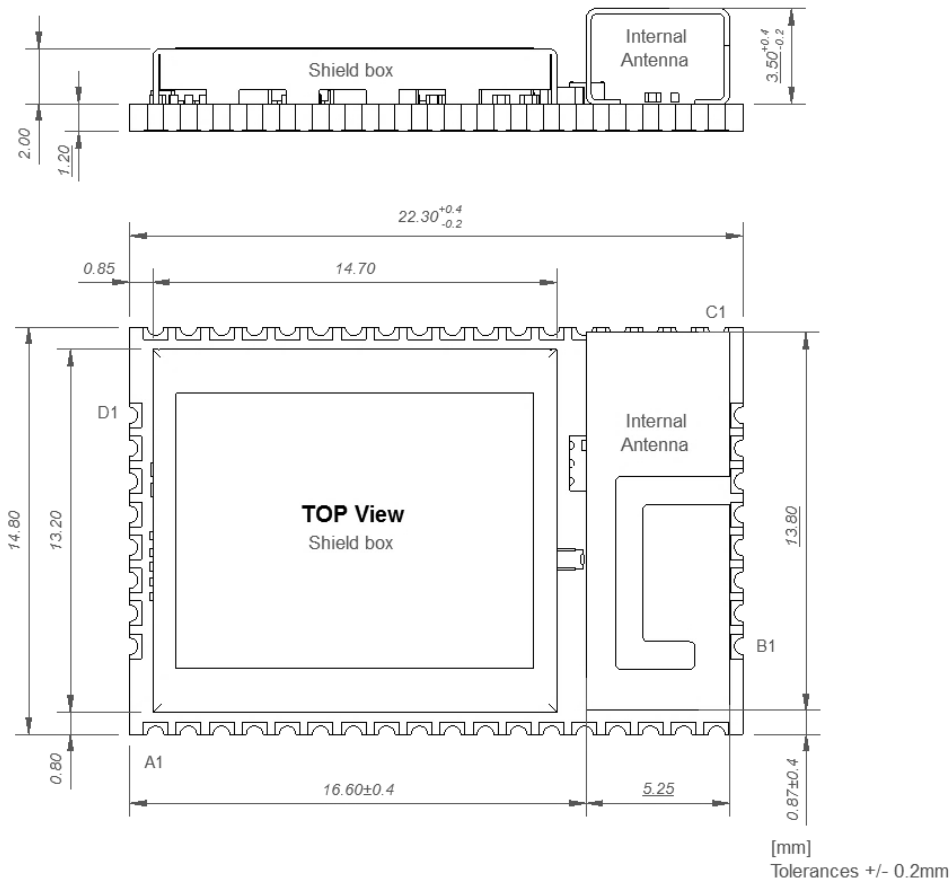

Figure 6: Physical dimensions of ODIN-W262

6.2 Module weight

Module	Typ	Unit
ODIN-W260	2	g
ODIN-W262	2	g

Table 29: Module weight

7 Qualification and approvals

7.1 Compliance with the RoHS directive

ODIN-W2 series modules comply with the Directive 2011/65/EU (EU RoHS 2) and its amendment Directive (EU) 2015/863 (EU RoHS 3).

7.2 European Union regulatory compliance

Information about regulatory compliance of the European Union for ODIN-W2 series modules is available in the ODIN-W2 Declaration of Conformity [\[4\]](#).

7.3 Safety compliance

 To fulfill EN 60950-1 safety standards, the unit must be supplied by a limited power source.

7.4 FCC and IC Compliance

 ODIN-W263 is configured to always support the ETSI domain and does NOT comply with FCC and IC. ODIN-W263 is only allowed to be used in countries allowing ETSI domain channels. See [Table 3](#).





7.4.1 IC compliance

This device complies with Industry Canada license-exempt RSS standard(s).

Operation is subject to the following two conditions:

1. this device may not cause interference, and
2. this device must accept any interference, including interference that may cause undesired operation of the device.

Under Industry Canada regulations, this radio transmitter may only operate using an antenna of a type and maximum (or lesser) gain approved for the transmitter by Industry Canada. To reduce potential radio interference to other users, the antenna type and its gain should be so chosen that the equivalent isotropically radiated power (e.i.r.p.) is not more than that necessary for successful communication.

-  The device for operation in the band 5150-5250 MHz is only for indoor use to reduce the potential for harmful interference to co-channel mobile satellite systems;
-  The maximum antenna gain permitted for devices in the bands 5250-5350 MHz and 5470-5725 MHz shall comply with the e.i.r.p. limit; and
-  The maximum antenna gain permitted for devices in the band 5725-5825 MHz shall comply with the e.i.r.p. limits specified for point-to-point and non point-to-point operation as appropriate.
-  Operation in the 5600-5650 MHz band is not allowed in Canada. High-power radars are allocated as primary users (i.e. priority users) of the bands 5250-5350 MHz and 5650-5850 MHz and that these radars could cause interference and/or damage to LE-LAN devices.

This equipment complies with IC RSS-102 radiation exposure limits set forth for an uncontrolled environment. This equipment should be installed and operated with minimum distance 20 cm between the radiator and your body.





7.4.2 Conformité aux normes d'IC

Cet appareil est conforme à la(aux) norme(s) RSS sans licence d'Industry Canada.

Son utilisation est soumise aux deux conditions suivantes :

1. Cet appareil ne doit pas causer d'interférences et
2. il doit accepter toutes interférences reçues, y compris celles susceptibles d'avoir des effets indésirables sur son fonctionnement.

Conformément aux réglementations d'Industry Canada, cet émetteur radio ne peut fonctionner qu'à l'aide d'une antenne dont le type et le gain maximal (ou minimal) ont été approuvés pour cet émetteur par Industry Canada. Pour réduire le risque d'interférences avec d'autres utilisateurs, il faut choisir le type d'antenne et son gain de telle sorte que la puissance isotrope rayonnée équivalente (p.i.r.e) ne soit pas supérieure à celle requise pour obtenir une communication satisfaisante.

-  Le dispositif de fonctionnement dans la bande 5150-5250 MHz est réservé à une utilisation en intérieur pour réduire le risque d'interférences nuisibles à la co-canal systèmes mobiles par satellite.
-  Le gain d'antenne maximal autorisé pour les appareils dans les bandes 5250-5350 MHz et 5470-5725 MHz doit se conformer à la pire limite, et
-  le gain d'antenne maximal autorisé pour les appareils dans la bande 5725-5825 MHz doivent être conformes avec le pire limites spécifiées à point-à-ponctuelles et non point-à-point de fonctionnement selon qu'il convient.
-  Opération dans la bande 5600-5650 MHz n'est pas autorisée au Canada. Haute puissance radars sont désignés comme utilisateurs principaux (c.-à-utilisateurs prioritaires) des bandes 5250-5350 MHz et 5650-5850 MHz et que ces radars pourraient causer des interférences et / ou des dommages à dispositifs LAN-EL.

Cet équipement respecte les limites d'exposition aux rayonnements IC RSS-102 définies pour un environnement non contrôlé. Il doit être installé et utilisé en maintenant une distance minimum de 20 cm entre le radiateur et votre corps.

7.4.3 FCC statement

This device complies with Part 15 of the FCC Rules. Operation is subject to the following two conditions:

1. this device may not cause harmful interference, and
2. this device must accept any interference received, including interference that may cause undesired operation.

 This equipment has been tested and found to comply with the limits for a Class B digital device, pursuant to Part 15 of the FCC Rules. These limits are designed to provide reasonable protection against harmful interference in a residential installation. This equipment generates, uses and can radiate radio frequency energy and, if not installed and used in accordance with the instructions, may cause harmful interference to radio communications. However, there is no guarantee that interference will not occur in a particular installation. If this equipment does cause harmful interference to radio or television reception, which can be determined by turning the equipment off and on, the user is encouraged to try to correct the interference by one or more of the following measures:

- Reorient or relocate the receiving antenna.
- Increase the separation between the equipment and receiver.
- Connect the equipment into an outlet on a circuit different from that to which the receiver is connected.

Consult the dealer or an experienced radio/TV technician for help.

The ODIN-W2 module is for OEM integrations only. The end-user product will be professionally installed in such a manner that only the authorized antennas are used.

Any changes or modifications NOT explicitly APPROVED by u-blox could cause the module to cease to comply with FCC rules part 15, and thus void the user's authority to operate the equipment.

7.4.3.1 Cautions

- ⚠ Any changes or modification could cause the module to cease to comply with FCC rules part 15 and thus void the user's authority to operate the equipment.
- ⚠ §15.407 statement; in case of absence of information to transmit or operational failure the module types ODIN-W2 will automatically discontinue transmission.

7.4.4 Labeling requirements for end product

For an end product using the ODIN-W260/ODIN-W262 modules there must be a label containing, at least, the following information:

This device contains FCC ID: PVH0965 IC: 5325A-0965

The label must be affixed on an exterior surface of the end product such that it will be visible upon inspection in compliance with the modular approval guidelines developed by the FCC.

In accordance with 47 CFR § 15.19 the end product shall bear the following statement in a conspicuous location on the device:

"This device complies with Part 15 of the FCC Rules.
Operation is subject to the following two conditions;
(1) this device may not cause harmful interference, and
(2) this device must accept any interference received, including interference that may cause undesired operation."

When the device is so small or for such use that it is not practicable to place the statement above on it, the information shall be placed in a prominent location in the instruction manual or pamphlet supplied to the user or, alternatively, shall be placed on the container in which the device is marketed.

In case, where the final product will be installed in locations where the end-user is not able to see the FCC ID and/or this statement, the FCC ID and the statement shall also be included in the end-product manual.

7.4.4.1 IC requirement

If the end product using the ODIN-W2 module is able to operate in the band 5150-5250 MHz within Canada (IC) it is only allowed to be used indoor to reduce the potential for harmful interference to co-channel mobile satellite systems. The label of the end product MUST in this case be marked with the text "For indoor use only":

This device contains FCC ID: PVH0965 IC: 5325A-0965 For indoor use only
--

When the device is so small or for such use that it is not practicable to place the statement above on it, the information shall be placed in a prominent location in the instruction manual or pamphlet supplied to the user or, alternatively, shall be placed on the container in which the device is marketed. However, the FCC ID label including the “For indoor use only” text must be displayed on the device.

7.5 Japan radio equipment compliance

- ODIN-W263 is configured to always support the ETSI domain and does NOT comply with Japan radio equipment compliance.

The ODIN-W260/ODIN-W262 module complies with the Japanese Technical Regulation Conformity Certification of Specified Radio Equipment (ordinance of MPT N°. 37, 1981), Article 2, Paragraph 1:

- Item 19 “2.4 GHz band wide band low power data communication system”
- Item 19-3 “Low power data communications system in the 5.2/5.3 GHz band”
- Item 19-3-2 “Low power data communications system in the 5.6 GHz band”

The ODIN-W2 module is restricted on the Japanese market to be used indoors only if the product is operating in the 5.2/5.3 GHz band. The information: “Indoor use only” translated into Japanese (この製品は屋内においてのみ使用可能です) must be visible:

- on the certified end product.
- on the product package in which the end product is marketed.
- in the users / installation manual of the end product.

The indoor usage information is recommended to be printed close to the Giteki mark but it is also permitted to place that information on another prominent position.

- The ODIN-W2 MIC certification number is 204-510009.

- The very small size of the module makes it not reasonable to fit the GITEKI mark and certification number onto the module label. Instead the Giteki mark and certification number is available in this document, as shown in [Figure 7](#).

When a product integrated with an ODIN-W260/ODIN-W262 module is placed on the Japanese market, it must have either of the following:

- The ODIN-W260/ODIN-W262 module is affixed with a label with the Giteki marking below. In this case, it is recommended that the product is marked with “Contains MIC ID: 204-510009”.
- The product be affixed with a label with the Giteki marking below. The marking must be visible for inspection.

[Figure 7](#) shows the Giteki mark and the ODIN-W260/ODIN-W262 MIC certification number, The “Indoor use only” information translated into Japanese below is mandatory if the product is operating in the 5.2/5.3 GHz band.



この製品は屋内においてのみ使用可能です

Figure 7: Giteki mark, and the ODIN-W260/ODIN-W262 MIC certification number

The recommended size of the Giteki mark is Ø5.0 mm but the minimum size is Ø3.0 mm.

The end product holder shall also include a copy of the Japan Radio Certificate to the end product technical documentation. See the Contact information in the end of this document for a copy of the Radio Certificate.

7.6 SRRC China Radio Transmission Equipment Type Approval

- ⚠ The ODIN-W262 SRRC approval expiry date is March 31, 2024. The CMIIT ID 2016AJ1533 and the information in this section is not valid after this date.
- ⚠ Only the ODIN-W262 is modular approved for integration in an end product on the Chinese market.

In accordance with the provisions on the Radio Regulations of the People's Republic of China, the ODIN-W262 module with the product name ODIN-W262 conforms to the provisions with its CMIIT ID: 2016AJ1533.

7.6.1 ODIN-W262 labeling requirements for end product

The following requirements apply for end products that are sold in China:

- Label with CMIIT ID number of the module is required to be placed on the end product.
- The following statement must be included in Chinese in the Chinese user manual:

CMIIT ID: 2016AJ1533

(This device contains certified RF module which certificate number is CMIIT ID: 2016AJ1533)

7.7 NCC Taiwan compliance

- ⚠ ODIN-W263 is configured to always support the ETSI domain and does NOT comply with Taiwan NCC compliance.

7.7.1 Taiwan NCC Warning Statement

- 經型式認證合格之低功率射頻電機，非經許可，公司、商號或使用者均不得擅自變更頻率、加大功率或變更原設計之特性及功能。
- 低功率射頻電機之使用不得影響飛航安全及干擾合法通信；經發現有干擾現象時，應立即停用，並改善至無干擾時方得繼續使用。前項合法通信，指依電信法規定作業之無線電通信。低功率射頻電機須忍受合法通信或工業、科學及醫療用電波輻射性電機設備之干擾。

Statement translation:

- Without permission granted by the NCC, any company, enterprise, or user is not allowed to change frequency, enhance transmitting power, or alter original characteristic as well as performance to an approved low power, radio-frequency devices.
- The low power radio-frequency devices shall not influence aircraft security and interfere legal communications; If found, the user shall cease operating immediately until no interference is achieved. The said legal communications means radio communications is operated in compliance with the Telecommunications Act. The low power radio-frequency devices must be susceptible with the interference from legal communications or ISM radio wave radiated devices.

7.7.2 ODIN-W260 labeling requirements for end product

When a product integrated with an ODIN-W260 module is placed on the Taiwan market, the product must be affixed with a label marking as shown below. The label can use wording such as the following:

Contains Transmitter Module

內含發射器模組:  CCAJ16LP1230T0

or any similar wording that expresses the same meaning may be used. The marking must be visible for inspection.

7.7.3 ODIN-W262 labeling requirements for end product

When a product integrated with an ODIN-W262 module is placed on the Taiwan market, the product must be affixed with a label marking as shown below. The label can use wording such as the following:

Contains Transmitter Module

內含發射器模組:  **CCAJ16LP1240T0**

or any similar wording that expresses the same meaning may be used. The marking must be visible for inspection.

7.8 Korean KCC certification

 ODIN-W263 is configured to always support the ETSI domain and does NOT comply with Korean KCC certification.



The ODIN-W260/ODIN-W262 modules are certified by the Korea Communications Commission (KCC).

The KCC IDs for ODIN-W260 and ODIN-W262 are provided below:

- ODIN-W260 module: MSIP-CRM-ULX-ODIN-W260
- ODIN-W262 module: MSIP-CRM-ULX-ODIN-W262

7.9 Brazil compliance

 ODIN-W263 is configured to always support the ETSI domain and does NOT comply with the Brazil compliance.

When a product containing ODIN-W260/ODIN-W262 module is placed on the Brazilian market, the product must be affixed with a label or marking containing the Anatel logo, ODIN-W260/ODIN-W262 Homologation number: 03883-16-05903 and a statement claiming that the device may not cause harmful interference but must accept it (Resolution No 506).



“Este equipamento opera em caráter secundário, isto é, não tem direito a proteção contra interferência prejudicial, mesmo de estações do mesmo tipo, e não pode causar interferência a sistemas operando em caráter primário.”

Statement translation:

“This equipment operates on a secondary basis and, consequently, must accept harmful interference, including from stations of the same kind, and may not cause harmful interference to systems operating on a primary basis.”

When the device is so small or for such use that it is not practicable to place the statement above on it, the information shall be placed in a prominent location in the instruction manual or pamphlet supplied to the user or, alternatively, shall be placed on the container in which the device is marketed.

In case, where the final product will be installed in locations where the end user is unable to see the Anatel logo, ODIN-W260/ODIN-W262 Homologation number and/or this statement, the Anatel logo, ODIN-W260/ODIN-W262 Homologation number, and the statement shall also be included in the end product manual.

7.10 Australia and New Zealand regulatory compliance

 ODIN-W263 is configured to always support the ETSI domain and does NOT comply with the Australia or New Zealand regulatory compliance.



The ODIN-W260 and ODIN-W262 modules are compliant with the standards made by the Australian Communications and Media Authority (ACMA).

The modules are compliant with AS/NZS 4268:2012 standard – Radio equipment and systems – Short range devices – Limits and methods of standard measurement. The ODIN-W2 module test reports can be used as part of the product certification and compliance folder. For more information on the test reports, send an email to the respective support team mail address as mentioned in the Contact section based on your location.

To meet overall Australian and/or New Zealand end product compliance, the integrator must create a compliance folder containing all the relevant compliance test reports such as RF, EMC, electrical safety and DoC (Declaration of Conformity) and so on. It is the responsibility of the integrator to know what is required in the compliance folder for ACMA compliance.

For more information on Australia compliance, refer to the Australian Communications and Media Authority web site <http://www.acma.gov.au/>.

For more information on New Zealand compliance, refer to the New Zealand Radio Spectrum Management Group web site www.rsm.govt.nz.

7.11 South Africa regulatory compliance

 ODIN-W263 is configured to always support the ETSI domain and does NOT comply with the South Africa regulatory compliance.

The ODIN-W260/ODIN-W262 modules are compliant and certified by the Independent Communications Authority of South Africa (ICASA). End products that are made available for sale or lease or is supplied in any other manner in South Africa shall have a legible label permanently affixed to its exterior surface. The label shall have the ICASA logo and the ICASA issued license number as shown in the figure below. The minimum width and height of the ICASA logo shall be 3 mm. The approval labels must be purchased by the customer's local representative directly from the approval authority ICASA. A sample of an ODIN-W260/ODIN-W262 ICASA label is included below:



More information on registration as a Responsible Integrator and labeling requirements can be found at the following website:

Independent Communications Authority of South Africa (ICASA) web site – <https://www.icasa.org.za>

7.12 Bluetooth qualification information



End products are required to be qualified and listed for the Bluetooth Special Interest Group (SIG).

Product declarations are submitted through the [Bluetooth SIG Launch Studio website](#).

The ODIN-W2 series modules have been qualified according to the Bluetooth 4.0 and the 4.2 specification.

To list your product that integrates ODIN-W2 towards the Bluetooth 4.2 specification as an End product with no required testing, combine the pre-qualified Controller Subsystem (QD ID 156961) and the Host Subsystem (QD ID 151198) listed in the table below.

 Listing ODIN-W2 towards the Bluetooth 4.2 specification is only possible for Software version 8.0.0 and onwards.

To list your product that integrates ODIN-W2 towards the Bluetooth 4.0 specification as an End product with no required testing, combine the pre-qualified Controller Subsystem (QD ID 71681) and the Host Subsystem (QD ID 40911) listed in the table below.

End product specification	Product type	QD ID	Listing date
4.2	Controller Subsystem	156961	17-Nov-2020
4.2	Host Subsystem	151198	30-Sep-2020
4.0	Controller Subsystem	71681	28-Aug-2015
4.0	Host Subsystem	40911	29-Jan-2013

Table 30: ODIN-W2 Bluetooth IDs

8 Antennas

This chapter gives an overview of the different external antennas that can be fitted to the ODIN-W2 module.

- ⚠ This radio transmitter IC: 5325A-0965 has been approved by Industry Canada to operate with the antenna types listed below with the maximum permissible gain and required antenna impedance for each antenna type indicated. Antenna types not included in this list, having a gain greater than the maximum gain indicated for that type, are strictly prohibited for use with this device.
- ⚠ Cet émetteur radio IC : 5325A-0965 été approuvé par Industry Canada pour fonctionner avec les types d'antenne énumérés ci-dessous avec le gain maximum autorisé et l'impédance nécessaire pour chaque type d'antenne indiqué. Les types d'antenne ne figurant pas dans cette liste et ayant un gain supérieur au gain maximum indiqué pour ce type-là sont strictement interdits d'utilisation avec cet appareil.

For each antenna, the “Approvals” field defines in which test reports the antenna is included. Definitions of the «Approvals» field are:

- FCC – The antenna is included in the FCC test reports and thus approved for use in countries that accept the FCC radio approvals, primarily US.
- IC – The antenna is included in the IC (Industrie Canada) test reports and thus approved for use in countries that accept the IC radio approvals, primarily Canada.
- RED – The antenna is included in the ETSI test reports and thus approved for use in countries that accept the Radio Equipment Directive, primarily the European countries.
- MIC – The antenna is included in the Japanese government affiliated MIC test reports and thus approved for use in the Japanese market.
- NCC – The antenna is included in the Taiwan NCC test reports and thus approved for use in Taiwan.
- KCC – The antenna is included in the Korea KCC test reports and thus approved for use in Korea.
- ANATEL – The antenna is included in the Brazil Anatel test reports and thus approved for use in Brazil.
- ICASA – The antenna is included in the South Africa ICASA test reports and thus approved for use in South Africa.

In general, antennas with SMD connection, Reverse Polarity SMA connector or U.FL connector are included in FCC, IC, RED, NCC, MIC, ANATEL and ICASA radio tests. The antennas with SMA connector are included in RED, NCC, MIC, ANATEL and ICASA radio tests but not in the FCC or IC due to FCC/IC regulations. Only dual band antennas are allowed to be used on the main antenna port in Korea. See [Antenna connectors and internal antenna](#).

- ⚠ Only the ODIN-W262 with internal antenna is modular approved for the China market. The ODIN-W260 with antenna connectors to be used with the external antennas is not approved to be used on the China market.

The external antennas are connected to the board through U.FL connectors. Some antennas are connected directly to the U.FL connector of the board while some are connected using an SMA or reversed polarity SMA connector through a short U.FL to SMA or reversed polarity SMA adapter cable.

8.1 Antenna accessories

Name	U.FL to SMA adapter cable
Connector	U.FL and SMA jack (outer thread and pin receptacle)
Impedance	50 Ω
Cable length	100-125 mm
Minimum cable loss	0.5 dB, The cable loss must be above the minimum cable loss to meet the regulatory requirements
Comment	The SMA connector can be mounted in a panel
Approval	RED, MIC, NCC, KCC, ANATEL, and ICASA



Name	U.FL to Reverse Polarity SMA adapter cable
Connector	U.FL and Reverse Polarity SMA jack (outer thread and pin)
Impedance	50 Ω
Cable length	100-125 mm
Minimum cable loss	0.5 dB, The cable loss must be above the minimum cable loss to meet the regulatory requirements
Comment	The Reverse Polarity SMA connector can be mounted in a panel
Approval	FCC, IC, RED, MIC, NCC, KCC, ANATEL, and ICASA



8.2 Approved antennas

8.2.1 Single band antennas

Ex-It 2400 28 RP-SMA, PN PRO-EX-348	
Manufacturer	Abracon
Polarization	Vertical
Gain	+3.0 dBi
Impedance	50 Ω
Size	\varnothing 12.0 x 28.0 mm
Type	Monopole
Connector	Reverse Polarity SMA plug (inner thread and pin receptacle). To be mounted on the U.FL to Reverse Polarity SMA adapter cable.
Comment	An SMA version antenna is also available but not recommended for use (Ex-IT 2400 SMA 28-001).
Approval	FCC, IC, RED, MIC, NCC, KCC*, ANATEL, and ICASA (certified unde PN Ex-IT 2400 RP-SMA 28-001)



Ex-It 2400 28 U.FL-100, PN PRO-EX-296	
Manufacturer	Abracon
Polarization	Vertical
Gain	+2.0 dBi
Impedance	50 Ω
Size	\varnothing 12.0 x 28.0 mm
Type	Monopole
Cable length	100 mm
Connector	U.FL. connector
Comment	To be mounted on the U.FL connector on the PCB.



Ex-It 2400 28 U.FL-100, PN PRO-EX-296

Approval FCC, IC, RED, MIC, NCC, KCC*, ANATEL, and ICASA
(certified under the PN Ex-IT 2400 MHF 28)

Ex-It 2400 Foldable RP-SMA, PN PRO-EX-333

Manufacturer	Abracon
Polarization	Vertical
Gain	+3.0 dBi
Impedance	50 Ω
Size	Ø 10 x 83 mm
Type	Monopole
Connector	Reverse Polarity SMA plug (inner thread and pin receptacle)
Comment	To be mounted on the U.FL to Reverse Polarity SMA adapter cable (cB-ACC-38). An SMA version antenna is also available but not recommended for use (Ex-IT 2400 SMA 70-002).
Approval	FCC, IC, RED, MIC, NCC, KCC*, ANATEL, and ICASA (certified under the PN Ex-IT 2400 RP-SMA 70-002)



Ex-It 2400 70, PN PRO-EX-327

Manufacturer	Abracon
Polarization	Vertical
Gain	+3.0 dBi
Impedance	50 Ω
Size	Ø 9.4 x 70.5 mm
Type	Monopole
Cable length	100 mm
Connector	U.FL. connector
Comment	To be mounted on the U.FL connector on the PCB.
Approval	FCC, IC, RED, MIC, NCC, KCC*, ANATEL, and ICASA (certified under the PN Ex-IT 2400 MHF 70-001)



InSide-2400, PN PRO-IS-237

Manufacturer	Abracon
Gain	+3.0 dBi
Impedance	50 Ω
Size	27 x 12 mm (triangular)
Type	Patch
Cable length	100 mm
Connector	U.FL. connector
Comment	To be mounted on the U.FL connector on the PCB.
Approval	FCC, IC, RED, MIC, NCC, KCC*, ANATEL, and ICASA



FlatWhip-2400

Manufacturer	Abracon
Gain	+3.0 dBi
Impedance	50 Ω
Size	Ø 50.0 x 30.0 mm

FlatWhip-2400

Type	Monopole
Connector	SMA plug (inner thread and pin)
Comment	To be mounted on the U.FL to SMA adapter cable. The product is End-Of-Life, not for new designs.
Approval	RED, MIC, NCC, KCC*, ANATEL, and ICASA

Outside-2400

Manufacturer	Abracon
Gain	+3.0 dBi
Impedance	50 Ω
Size	36.0 x 18.0 x 16.0 mm
Type	Patch
Cable length	70 mm
Connector	U.FL. connector
Comment	To be mounted on the U.FL connector on the PCB. The product is End-Of-Life, not for new designs.
Approval	FCC, IC, RED, MIC, NCC, KCC*, ANATEL, and ICASA



* In Korea is only dual band antennas allowed on the main antenna port and 2.4 GHz single band antennas are only allowed on the MIMO antenna port.

8.2.2 Dual-band antennas

InSide-WLAN, PN PRO-IS-299

Manufacturer	Abracon
Gain	+3.0 dBi
Impedance	50 Ω
Size	27 x 12 mm (triangular)
Type	Patch
Cable length	100 mm
Connector	U.FL. connector
Comment	Dual-band (2.4 GHz/ 5 GHz) antenna to be mounted on the U.FL connector on the PCB.
Approval	FCC, IC, RED, MIC, NCC, KCC*, ANATEL, and ICASA

InSide-WLAN Square, PN PRO-IS-432

Manufacturer	Abracon
Gain	+3.0 dBi
Impedance	50 Ω
Size	24x22x1 mm with mounting hole
Type	Patch
Cable length	100 mm
Connector	U.FL. connector
Comment	Dual-band (2.4 GHz / 5 GHz) antenna to be mounted on the U.FL connector on the PCB.
Approval	FCC, IC, RED, MIC, NCC, KCC*, ANATEL, and ICASA

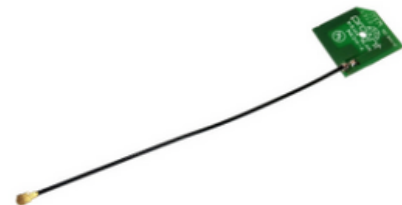

Ex-It WLAN Foldable RP-SMA, PN PRO-EX-286

Manufacturer	Abracon
Type	½ wave dipole dual-band antenna
Polarization	Vertical
Gain	+3 dBi
Impedance	50 Ω
Size	107 mm (Straight)
Type	Monopole
Connector	Reverse Polarity SMA plug (inner thread and pin receptacle) SMA plug (inner thread and pin)
Comment	To be mounted on the U.FL to SMA or reverse polarity SMA adapter cable.
Approval	FCC, IC, RED, MIC, NCC, KCC*, ANATEL, and ICASA (certified under the PN Ex-IT WLAN RPSMA)



9 Product handling and soldering

9.1 Packaging

ODIN-W2 series modules are delivered as hermetically sealed, reeled tapes to enable efficient production, production lot set-up and tear-down. For more information about packaging, see the u-blox package Information guide [3].

9.1.1 Reels

ODIN-W2 series modules are delivered on the reel as described in Table 31:

Parameter	Specification
Reel type	B2
Delivery quantity	200

Table 31: Reel information for ODIN-W2 series modules

9.1.2 Tapes

Figure 8 shows the position and the orientation of ODIN-W2 modules as they are delivered on the tape, while Figure 9 specifies the tape dimensions.

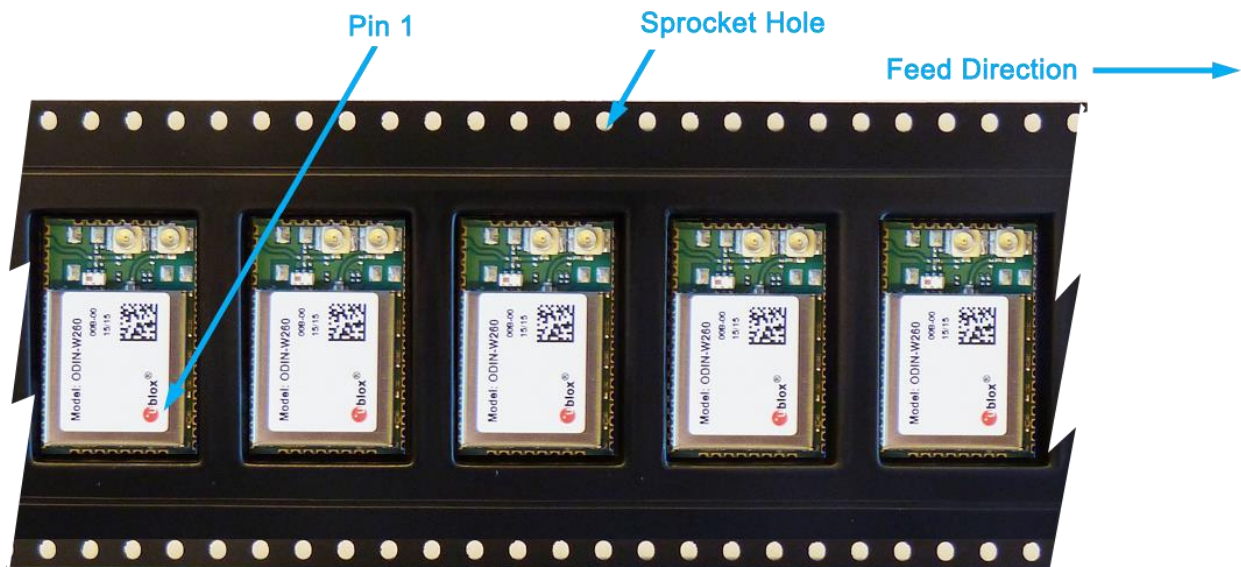
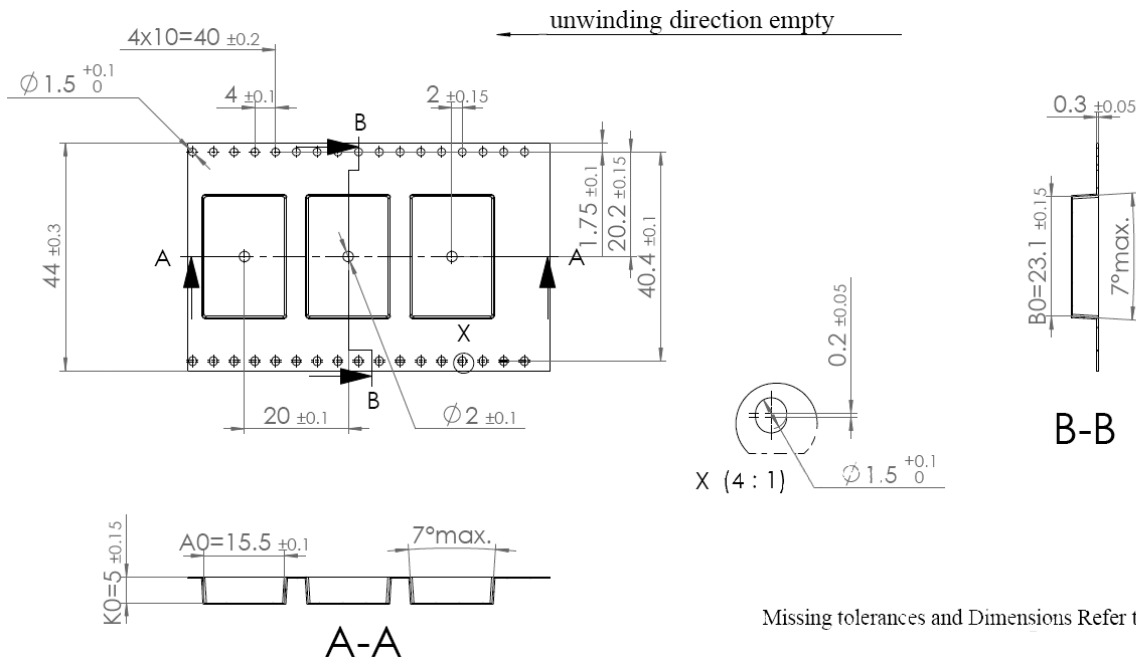

Figure 8: Orientation for ODIN-W2 modules on tape



Missing tolerances and Dimensions Refer to EIA - 481

Figure 9: ODIN-W2 series tape dimensions

9.2 Moisture sensitivity levels

- ⚠ ODIN-W2 series modules are Moisture Sensitive Devices (MSD) in accordance with the IPC/JEDEC specification.

The Moisture Sensitivity Level (MSL) relates to the required packaging and handling precautions. The ODIN-W2 series modules are rated at MSL level 4. For more information regarding moisture sensitivity levels, labeling, and storage, see the u-blox product packaging guide [3].

- 📖 For MSL standards, see IPC/JEDEC J-STD-020, which can be downloaded from www.jedec.org.

9.3 Reflow soldering

Reflow profiles are to be selected according to u-blox recommendations. See also the ODIN-W2 series system integration manual [2].

- ⚠ Failure to observe these recommendations can result in severe damage to the device.

9.4 ESD precautions

- ⚠ ODIN-W2 series modules contain highly sensitive electronic circuitry and are Electrostatic Sensitive Devices (ESD). Handling the ODIN-W2 series modules without proper ESD protection may destroy or damage them permanently.

ODIN-W2 series modules are electrostatic sensitive devices (ESD) and require special ESD precautions typically applied to ESD sensitive components. The Maximum ESD section reports the maximum ESD ratings of the ODIN-W2 series modules.

Proper ESD handling and packaging procedures must be applied throughout the processing, handling and operation of any application that incorporates the ODIN-W2 series module. The ESD precautions should be implemented on the application board where the module is mounted as described in the ODIN-W2 series system integration manual [2].

- ⚠ Failure to observe these recommendations can result in severe damage to the device.

10 Labeling and ordering information

10.1 Label information

The labels of the ODIN-W2 series modules include important product information as described in this section.

Figure 8 illustrates the label of all the ODIN-W2 series modules, which includes product type number and revision, production date, Data Matrix with unique serial number (MAC address), u-blox logo and regulatory certification numbers (if applicable). Because of space constraints, all certification numbers are not printed on the label. For more information about certification IDs, see also [Qualification and approvals](#).

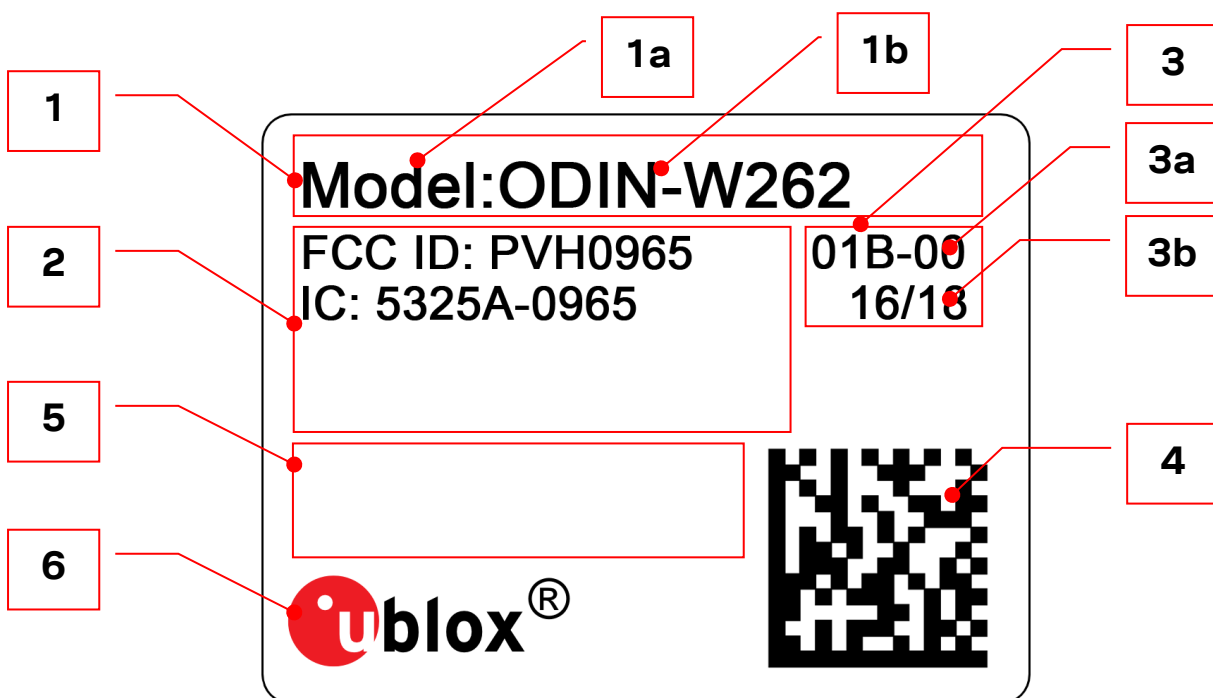

Figure 10: Location of product type number on the ODIN-W262-01B module label

Reference	Description
1	Text area containing product model name
2	Text area containing regulatory certification IDs
3	Text area containing Product Revision and date of production
3a	Major and minor product version info
3b	Date of unit production encoded YY/WW (year, week)
4	Data Matrix with unique serial number of 19 alphanumeric symbols. The 3 first symbols represent a unique module type number. The next 12 symbols represent the unique hexadecimal Ethernet MAC address of the module AABBCDDEEFF, and the last 4 symbols represent the hardware and software version encoded HFFF. See also MAC addresses .
5	Certifications logos area
6	u-blox logo. Preprinted on label. The red dot is also indicating pin 1.

Table 32: Label description of ODIN-W260 and ODIN-W262 standard product.

10.2 Explanation of codes

Three different product code formats are used. The **Product Name** is used in documentation such as this data sheet and identifies all u-blox products, independent of packaging and quality grade. The **Ordering Code** includes options and quality, while the **Type Number** includes the hardware and software versions. [Table 33](#) describes these three different formats:

Format	Structure
Product Name	PPPP-TGRV
Ordering Code	PPPP-TGRV-TTQ
Type Number	PPPP-TGRV-TTQ-XX

Table 33: Product code formats

[Table 34](#) describes the parts of the product code.

Code	Meaning	Example
PPPP	Form factor	ODIN
TG	Platform (Technology and Generation) T – Dominant technology, For example, W: Wi-Fi, B: Bluetooth G – Generation	W2: Wi-Fi Generation 2
R	Wireless technology; range [0...9]	6: Multi-radio dual-band 2.4+5GHz
V	Variant based on the same platform; range [00...99]	0: default mounting, with connector for external antenna
TT	Major Product Version	00: first revision
Q	Quality grade A: Automotive B: Professional C: Standard X: ATEX	B: professional grade
XX	Minor product version (not relevant for certification)	Default value is 00

Table 34: Part identification code

10.3 Ordering information

Ordering code	Product
ODIN-W260-05B	Wi-Fi IEEE802.11a/b/g/n (dual-band) 2.4 GHz 2x2 MIMO and Bluetooth dual-mode module with dual U.FL. coaxial antenna connectors. u-blox connectivity software version 6.0.0.
ODIN-W260-06B	Wi-Fi IEEE802.11a/b/g/n (dual-band) 2.4 GHz 2x2 MIMO and Bluetooth dual-mode module with dual U.FL. coaxial antenna connectors. u-connectXpress version 7.1.0.
ODIN-W260-07B	Wi-Fi IEEE802.11a/b/g/n (dual-band) 2.4 GHz 2x2 MIMO and Bluetooth dual-mode module with dual U.FL. coaxial antenna connectors. u-connectXpress version 8.4.0.
ODIN-W262-05B	Wi-Fi IEEE802.11a/b/g/n (dual-band) and Bluetooth dual-mode module with internal dual-band antenna. u-blox connectivity software version 6.0.0.
ODIN-W262-06B	Wi-Fi IEEE802.11a/b/g/n (dual-band) and Bluetooth dual-mode module with internal dual-band antenna. u-connectXpress version 7.1.0.
ODIN-W262-07B	Wi-Fi IEEE802.11a/b/g/n (dual-band) and Bluetooth dual-mode module with internal dual-band antenna. u-connectXpress version 8.4.0.
ODIN-W263-06B	Wi-Fi IEEE802.11a/b/g/n (dual-band) and Bluetooth dual-mode module with internal dual-band antenna. u-connectXpress version 7.1.0. ODIN-W263 is configured to always support the ETSI domain and is only allowed to be used in countries allowing ETSI domain channels.

Table 35: Product ordering codes

Appendix

A Glossary

Abbreviation	Definition
ADC	Analog to digital converter
BT	Bluetooth
CAN	Controller area network
CTS	Clear to send
DC	Direct current
DSR	Data set ready
DTR	Data terminal ready
EIRP	Equivalent isotropically radiated power
GND	Ground
GPIO	General purpose input output
H	High
HW	Hardware
I	Input (means that this is an input port of the module)
IEEE	Institute of Electrical and Electronics Engineers
L	Low
LPO	Low power oscillator
MIMO	Multi-Input Multi-Output
N/A	Not applicable
O	Output (means that this is an output port of the module)
PCN / IN	Product change notification / Information note
PD	Pull-Down
PU	Pull-Up
RMII	Reduced media independent interface
RTS	Request to send
RXD	Receive data
SMI	Station management interface
SPI	Serial peripheral interface
TXD	Transmit data
UART	Universal Asynchronous Receiver-Transmitter serial interface
ASCII	American Standard Code for Information Interchange
ARM	Arm (Advanced RISC Machines) Holdings
AEC	Automotive electronics council
BBR	Battery backed RAM
BER	Bit error rate
CPU	Central processing unit
UTC	Coordinated universal time
DCE	Data circuit-terminating equipment* / Data communication equipment*
DTE	Data terminal equipment
DC	Direct current
DRX	Discontinuous reception
DDC	Display data channel

Abbreviation	Definition
DL	Down link (Reception)

Table 36: Explanation of the abbreviations and terms used

Related documents

- [1] u-connectXpress AT commands manual, [UBX-14044127](#)
- [2] ODIN-W2 series, system integration manual, [UBX-14040040](#)
- [3] u-blox product packaging guide, [UBX-14001652](#)
- [4] ODIN-W2 declaration of conformity, [UBX-15024695](#)
- [5] s-center user guide, [UBX-16012261](#)

 For product change notifications and regular updates of u-blox documentation, register on our website, www.u-blox.com.

Revision history

Revision	Date	Name	Comments
R01	05-Sep-2014	mwej	Initial release.
R02	16-Feb-2015	fbro	Minor updates
R03	23-Apr-2015	ajoh	Updated features list, added input from early measurements and label specification.
R04	08-July-2015	fbro, kgom	Applied u-blox word template.
R05	22-Sept-2015	mwej, kgom	Major updates. Updated some IO voltage levels and some tolerances. Clarified mechanical outline. Updated performance measurements with ODIN-W26x SPA FW v0.11.05. Updated after type approval with approval information. Updated Table 1 similar to the ODIN-W2 series Product Summary.
R06	29-Jan-2016	mwej, pber	Added ETSI, FCC, IC, Japan approval certification information. Added Bluetooth Qualification information. Added list of approved antennas. Removed two unavailable test points from Mechanical dimensions (correction). Provided reference to ODIN-W2 Declaration of Conformity (UBX-15024695). Changed Document status to Early Production Information. Removed n rate characteristics (will be added when supported). Modified Table 1 and Table 2. Updated section 1.1 and section 5.4 (values in Table 21 to Table 28).
R07	16-Jun-2016	mwej, kgom	Updated product features (Table 1). Modified Updated to product version ODIN-W260-01B and ODIN-W262-01B due to firmware update. Updated label (section 10.2). Added MAC address information (section 1.8). Power saving mode implemented and current consumption reduced in idle mode (modified Table 15 – Table 19). Added Taiwan, China and Korea approval certification information (section 7.8 and section 8). Updated order information (Table 35).
R08	18-Jul-2016	mwej, kgom	Updated product features (Table 1). Added compliance information for Australia and New Zealand (section 7.9).
R09	06-Oct-2016	mwej, kgom	Updated the Product features (Table 1) and applicable products Table (page 2) with Firmware 3.0. Added antenna type information in section 8.2. Updated Australia and New Zealand compliance information (section 7.9) and tape orientation (section 9.1.2). Removed the information in European Union regulatory compliance (section 7.2) and provided reference to the ODIN-W2 Declaration of Conformity (UBX-15024695).
R10	02-Dec-2016	mwej	Updated document status to “Production Information”. Updated number of Test points (TP) to 51 in Figure 5. Removed reference to system integration manual in section 7.5. Added channel information in Access Point mode (Table 2). Added information about support for IEEE 802.11d/e/i/h (h:DFS client only) in Table 2.
R11	10-Jan-2017	ajoh, ecar, kgom	Updated Product ordering codes. Included support for ODIN-W2 firmware versions – 2.0.2 and 3.0.1. On page 2, replaced Document status with Disclosure restriction.
R12	30-Mar-2017	mwej	Updated Product ordering codes (Table 35). Included support for ODIN-W2 firmware version – 4.0.0. Added type approval information for Brazil and South Africa (chapters 7 and 8).
R13	01-Sep-2017	mwej, kgom	Included support for ODIN-W2 software version 4.0.1. Updated Table 1 and section 10. Added information about cable length limitation (section 2 and 0). Replaced R&TTE with RED (chapter 8). Replaced firmware with software.
R14	22-Dec-2017	mwej	Added support for ODIN-W2 software version 5.0.0. Updated with support for 802.11n. Updated the power consumption for Wi-Fi (section 5.3). Updated the ordering information (Table 35).
R15	26-Jan-2018	ecar, kgom	Included support for ODIN-W2 software version 5.0.1. In Table 35, changed the u-blox connectivity software version to 5.0.1 for the ordering code ODIN-W26x-04B.
R16	11-Jul-2018	mwej, kgom	Included support for ODIN-W2 software version 6.0.0. Updated Table 1. Updated MAC address example (section 1.8).
R17	14-Nov-2018	mwej, mhan	Included support for ODIN-W2 software version 6.0.1. Updated information about ODIN-W2 ATEX certified variants. Updated product ordering codes with additional variants (Table 35).

Revision	Date	Name	Comments
R18	18-Dec-2018	mwej	Updated product version table on page 2 with hardware version. Removed ODIN-W260-00B and ODIN-W262-00B from orderable products (section 10.3). Added information about Wi-Fi channel bandwidth (sections 1.5 and 5.4.1).
R19	10-Sep-2019	mwej, kgom	Included support for ODIN-W2 software version 7.1.0. Updated Table 1. Removed information about ODIN-W2 software version 4.0.0 and earlier. Added information about System IO signals (section 3.3). Included RoHS 3 compliance (section 7.1).
R20	19-Dec-2019	mwej	Added ODIN-W263-06B product variant.
R21	5-Jun-2020	mwej	Updated applicable product version table on page 2.
R22	8-Jun-2020	hekf	Added ESD indirect contact discharge and footnote in section 5.1.1.
R23	10-Sep-2020	mlju	Updated the product status of applicable products in Document information.
R24	6-Oct-2020	ecar, mape	Removed obsolete (EOL) variants from Document information. Slave -> Peripheral
R25	3-Mar-2021	mwej, fkru	Updated to Bluetooth 4.2. Removed -04B and -05X products in Table 35. Added Bluetooth 4.2 and Bluetooth SIG listing details.
R26	14-Dec-2023	hekf, mlju	Updated Proant antenna names and part numbers from Abracon due to acquisition of supplier Proant by Abracon, in Approved antennas . Added note that the antennas FlatWhip and Outside are End-Of-Life, in Approved antennas . Updated product status for ODIN-W260-06B-01 and ODIN-W263-06B-01 to Mass production in Document information . Added note about SRRC China certification expiry date in section SRRC China Radio Transmission Equipment Type Approval .
R27	02-Jul-2025	hisa, ialb	Added new ordering codes ODIN-W260-07B and ODIN-W262-07B in Ordering information . Set product status for the ODIN-W2 series to Not recommended for new design. Changed status to End of Life for ODIN-W2 modules with older software versions 6.0 and 7.1 (ODIN-W26x-05B and ODIN-W26x-06B).

Contact

u-blox AG

Address: Zürcherstrasse 68
8800 Thalwil
Switzerland

For further support and contact information, visit us at www.u-blox.com/support.